

# Fuller Heavy-Duty Transmissions TRTS0011 EN-US

October 2007

RTLO-11118A-MT  
RTLO-9118A-MT



*Powering Business Worldwide*

BACKED BY

**Roadranger**

SUPPORT

For parts or service call us  
Pro Gear & Transmission, Inc.



**1 (877) 776-4600**

**(407) 872-1901**

**parts@eprogear.com**

**906 W. Gore St.**

**Orlando, FL 32805**





## Introduction

WARNING.....	2
Complaint Isolation, Verification & Remedy Procedure.....	3
How to Use this Troubleshooting Guide.....	4

## Complaint Diagnosis

Fault Code Diagnosis.....	6
Symptom Driven Diagnosis.....	7

## Pre-Test

Transmission Electrical Test.....	8
-----------------------------------	---

## Performance Evaluation

Performance Evaluation Test.....	10
----------------------------------	----

## Testing Procedures

Power Relay Coil Test.....	12
System Voltage Test.....	13
Inertia Brake Solenoid Coil Test.....	15
Inertia Brake Test.....	17
Inertia Brake Switch Test.....	18
Inertia Brake Air Supply Test.....	19
Transmission Converter Open Lamp Test.....	20
Engine Speed Sensor Test.....	21
Bypass/Lockup Solenoid Coil Test.....	23
Interrupt Clutch Solenoid Coil Test.....	25
Hydraulic System Test.....	27
Input Shaft Speed Sensor Test.....	29
Output Shaft Speed Sensor Test.....	31

## Appendix I

System Overview.....	33
Electrical Schematic.....	34
Wiring Diagram (fold-out page)	

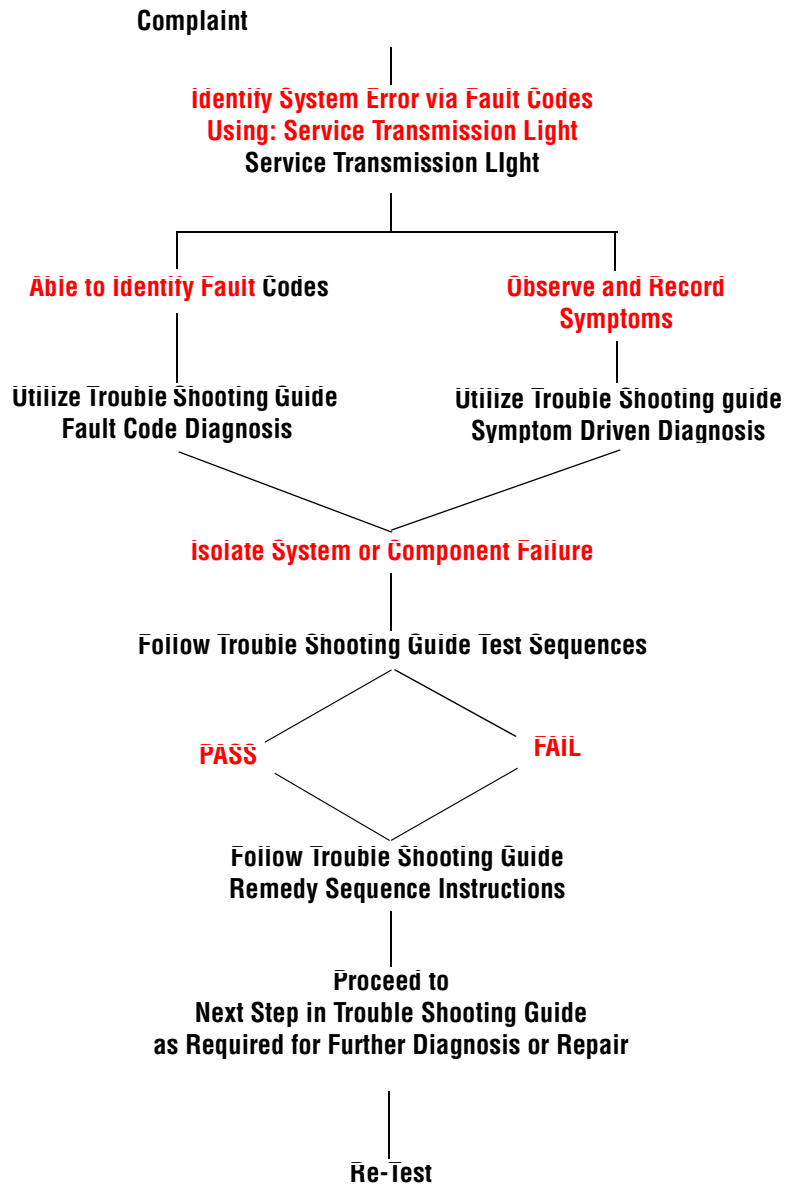


# WARNING

- Before starting a vehicle always be seated in the driver's seat, move the shift lever to neutral, and set the parking brakes.
- If engine cranks in any other gear than neutral, service your vehicle neutral safety start circuit and start enable relay circuit immediately.
- Before working on a vehicle or leaving the cab with engine running, place the transmission in neutral, set the parking brakes, AND block the wheels.
- Do not release the parking brake or attempt to select a gear until the air pressure is at the correct level.
- For safety reasons, always engage the service brakes when moving the shift lever from neutral to one of the other gear positions.
- When parking the vehicle or leaving the cab, always place the shift lever in neutral and set the parking brakes.
- TOWING: To avoid damage to the transmission during towing, place the transmission in neutral and lift the drive wheels off the ground or disconnect the driveline.

Every effort has been made to ensure the accuracy of all information in this manual. However, Eaton Transmission Division makes no expressed or implied warranty or representation based on the enclosed information. Any errors or omissions may be reported to Training and Publications, Eaton Transmission Division, P.O. Box 4013, Kalamazoo, MI 49003

## Complaint Isolation, Verification & Remedy Procedure



For all questions concerning inspection, removal, replacement, or adjustment procedures, refer to Eaton or OEM Service and Parts Literature.

### How To Use this Troubleshooting Guide

The purpose of this manual is to assist in the diagnosis and verification of your electronically managed heavy-duty transmission system. It should be used in conjunction with Eaton Driver Instructions, Illustrated Parts List, Installation Guide, and Service Manual -- as well as OEM service related material.

#### This guide provides three functions:

1. **Service Transmission Light Diagnostics:** designed to lead the service technician to the source of a problem through flashing error codes.
2. **Performance Evaluation:** designed to lead the service technician to the source of a problem through a performance evaluation.
3. **Test and remedy Sequences:** detailed component testing designed to isolate and resolve system failures.

#### Service Transmission Light Diagnostics

The Service Transmission indicator light, which is also the torque converter open lamp, assists the mechanic in problem diagnosis via flashing signals equal to Fault Code numbers as listed in the Fault Codes Diagnosis section of this manual.

If a driver reports a degraded mode of operation, advise that the capabilities of the truck should be assessed and then taken to a service site. **The transmission temperature should be monitored during the trip to the service site.**

Examples of potential problem conditions under which a vehicle with a Converter Enhanced Mechanical Transmission can be driven include:

- Transmission fails to lock torque converter, but vehicle can still proceed although speed and/or power is limited.
  - Transmission is not able to select all ratios and limits the gears available.
1. **Using the Service Transmission Light for Diagnostics:** To activate the retrieval of fault codes via the Service Transmission light perform the following steps:
    - Active Codes: Place the Shift Lever in Neutral. Set the parking brakes. Begin with the key in the off position. Turn the key off and back on two (2) times within 5 seconds (OFF/ON/OFF/ON). It is OK if the engine stops, or continues running, however do not re-energize the starter when retrieving Fault Codes as you may cause codes to clear.
    - If there are no active fault codes, then retrieve the intermittent codes.
    - Intermittent codes: Follow instructions for Active Codes, but turn key OFF and ON four (4) times.
    - To clear fault codes: Follow instructions for Active Codes, but turn key OFF and ON six (6) times. Fault codes should be cleared each time the transmission is serviced.

- 1a. After activating the retrieval of codes, to read transmission errors via the Service Transmission light, observe the sequence of flashes exhibited by the light. The Service Transmission light will flash in coded sequences equal to Fault Codes identified in this manual. A long pause (5 seconds) follows each code before it is repeated, or the next codes sequence is given.

Examples:

- Flash / Pause / Flash = Fault Code 11 System Controller
  - Flash - Flash / Pause / Flash - Flash - Flash = Fault Code 23 Engine Speed Sensor
  - Flash / Pause / Flash - Long Pause - Flash - Flash / Pause / Flash - Flash - Flash = Fault Codes 11 & 23.
- 1b. To identify fault codes and applicable tests signalled by the Service Transmission light refer to the Fault code Diagnosis section of this manual.

### Symptom Diagnosis

1. Refer to the Performance Evaluation test in this manual.
2. Locate and perform appropriate Test Sequence as indicated by the Performance Evaluation Test.

### Before Beginning Diagnostic Procedures

It is possible to “clear” or “reset” the Converter Enhanced Mechanical Electronic Control Unit (ECU) for some transmission errors. If the transmission is not functioning properly try these steps before beginning diagnostic procedures:

1. Stop the vehicle.
2. Place the shift lever in neutral.
3. Set the parking brakes.
4. Turn off the engine/ignition and wait for one minute.
5. Restart the engine.
6. Resume operation.

### Test Sequence and Remedy Sequence

1. Locate the correct Test Sequence.
2. Always perform pre-test procedures found at the top of each Test Sequence page before beginning test procedure.
3. Follow test steps in sequence.
4. Go to Remedy Sequence when required.
5. Perform appropriate removal, replacement or adjustment procedures.

For all questions concerning inspection, removal, replacement, or adjustment procedures, refer to Eaton or OEM Service and Parts Literature.



**Fault**

**Code**

**Diagnosis**

For all questions concerning inspection, removal, replacement, or adjustment procedures, refer to Eaton or OEM Service and Parts Literature.

<b>Fault Code</b>	<b>Test Procedure</b>	<b>Page</b>
<b>13</b>	Power Relay Coil Test	12
<b>15</b>	Inertial Brake Solenoid Coil Test	15
<b>22</b>	Bypass/Lockup Solenoid Coil Test	23
<b>23</b>	Engine Speed Sensor Test	21
<b>33</b>	System Voltage Test	13
<b>56</b>	Input Shaft Speed Sensor Test	29
<b>57</b>	Output Shaft Speed Sensor Test	31

If no fault codes exist perform the Performance Evaluation Test. Locate and perform appropriate test sequence as indicated by the evaluation.

**Symptom**

**Driven**

**Diagnosis**

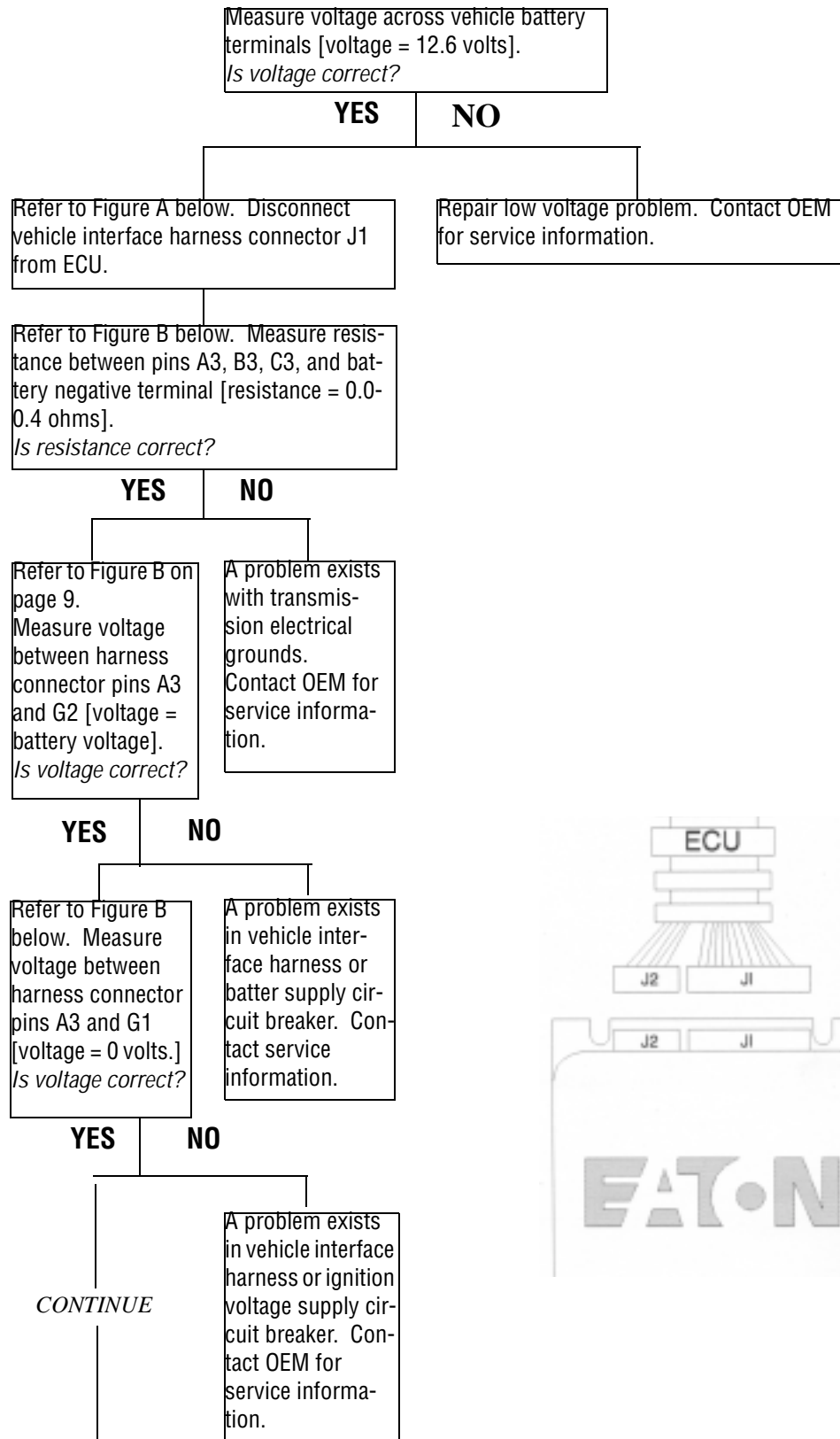
For all questions concerning inspection, removal, replacement, or adjustment procedures, refer to Eaton or OEM Service and Parts Literature.

# Transmission

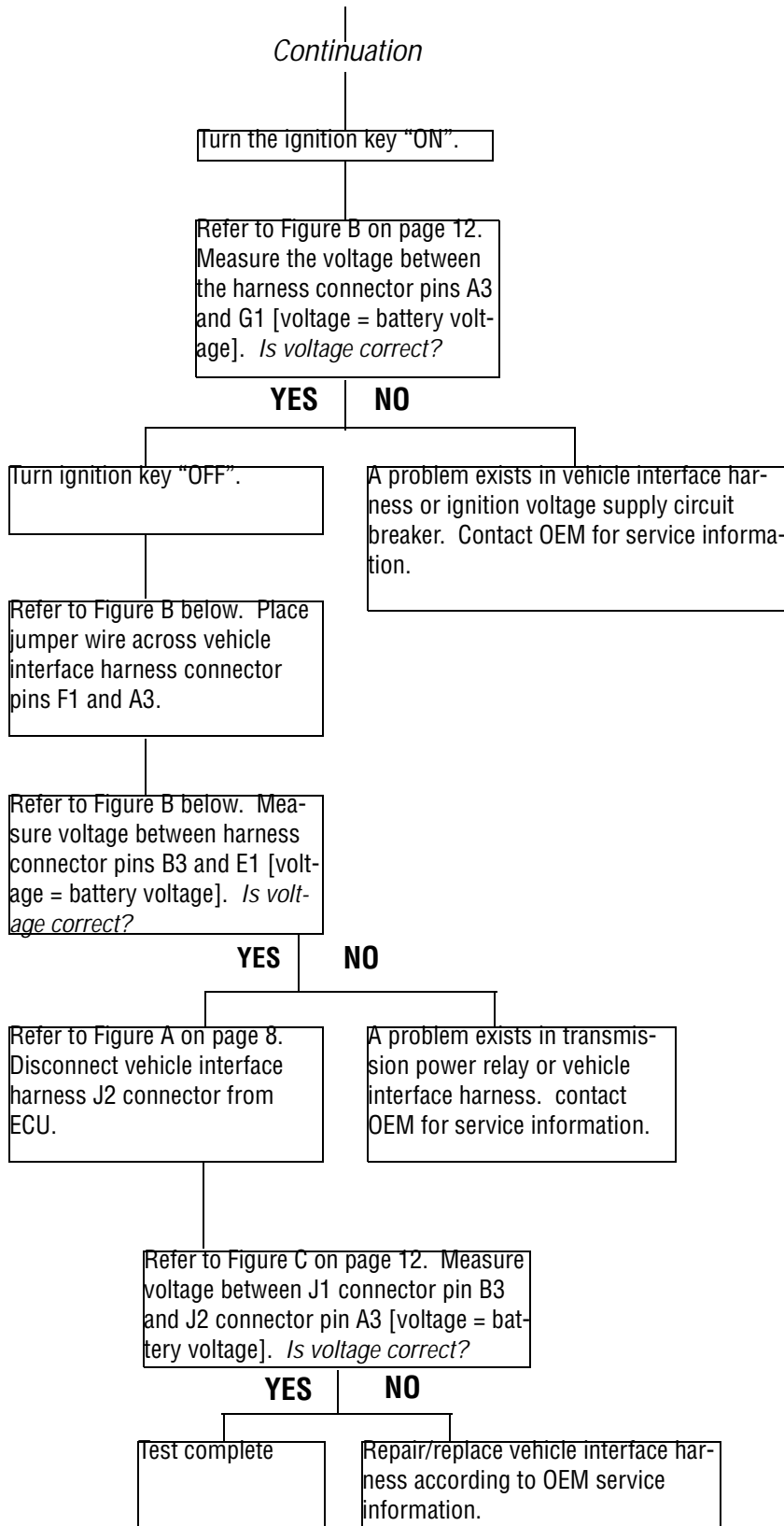
## Electrical

### Test

For all questions concerning inspection, removal, replacement, or adjustment procedures, refer to Eaton or OEM Service and Parts Literature.



For all questions concerning inspection, removal, replacement, or adjustment procedures, refer to Eaton or OEM Service and Parts Literature.

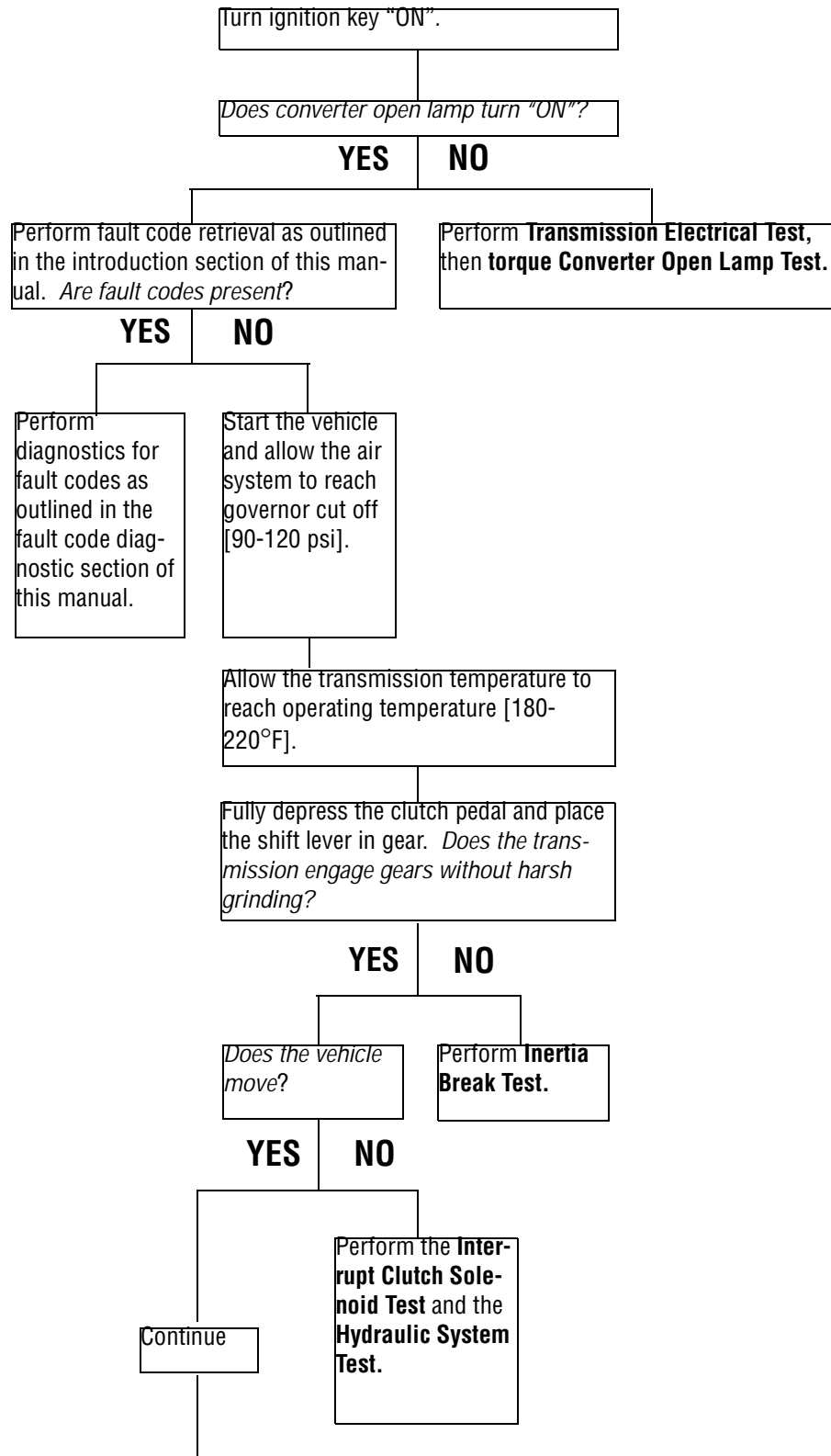


# Performance Evaluation Test

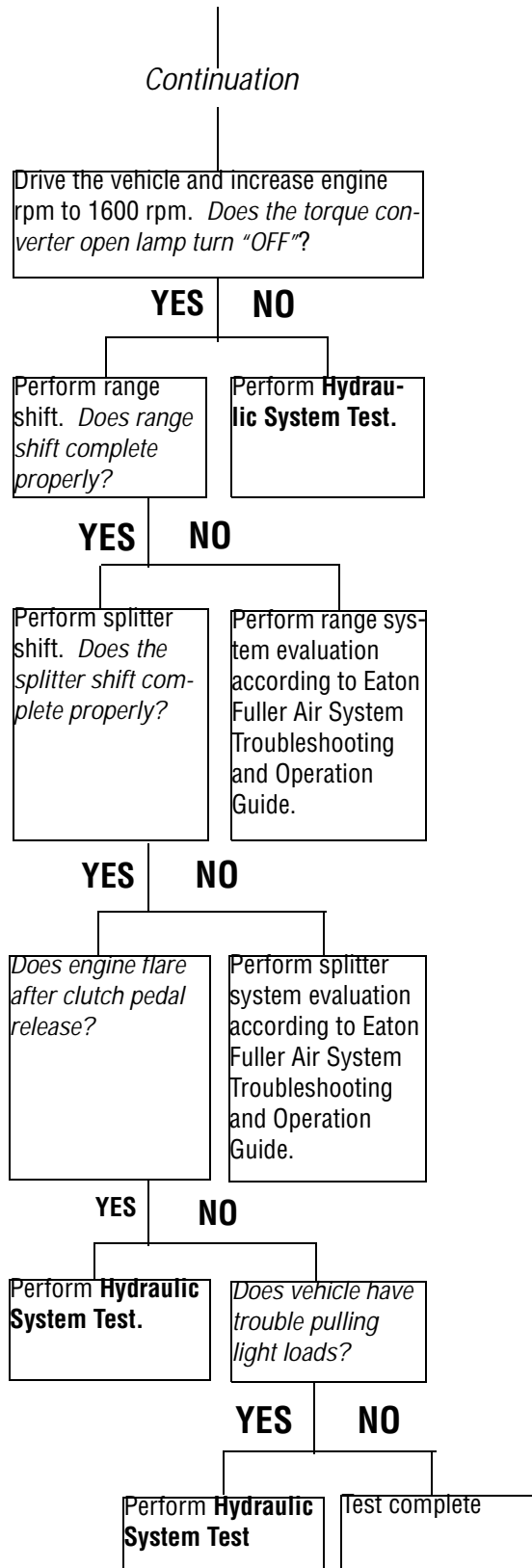
For all questions concerning inspection, removal, replacement, or adjustment procedures, refer to Eaton or OEM Service and Parts Literature.

**Before beginning test procedure:**

1. Set parking brakes.
2. Perform Transmission Electrical Test.
3. Turn ignition key "OFF".



For all questions concerning inspection, removal, replacement, or adjustment procedures, refer to Eaton or OEM Service and Parts Literature.



# Power

# Relay

# Coil

# Test

For all questions concerning inspection, removal, replacement, or adjustment procedures, refer to Eaton or OEM Service and Parts Literature.

### Before beginning test procedure:

1. Set parking brakes.
2. Perform Transmission Electrical Test.
3. Turn ignition key "OFF".

Refer to Figure A below. Disconnect vehicle interface harness J1 connector from the transmission ECU.

Refer to Figure B below. Measure resistance between J1 connector pins F1 and G2 [resistance = 40-90 ohms]. Measure voltage between G2 and vehicle ground, F1 and vehicle electrical ground [should = battery voltage].

**YES**      **NO**

Replace transmission ECU.

Locate power relay assembly and disconnect vehicle interface harness from relay assembly.

Refer to Figure C below. Measure resistance between pins 85 and 86 of each power relay [resistance = 40-90 ohms]. *Is resistance correct?*

**YES**      **NO**

Replace vehicle interface harness according to OEM service information.

Replace power relay assembly according to OEM service information.

Test complete

Figure A: Vehicle Interface Harness



Figure B: Connector J1

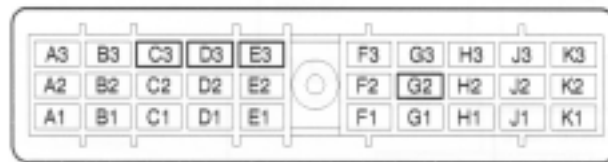
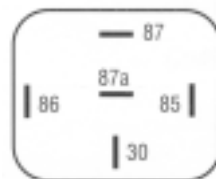


Figure C: Relay Connector



For all questions concerning inspection, removal, replacement, or adjustment procedures, refer to Eaton or OEM Service and Parts Literature.

**Before beginning test procedure:**

1. Set parking brakes.
2. Perform Transmission Electrical Test.
3. Turn ignition key "OFF".

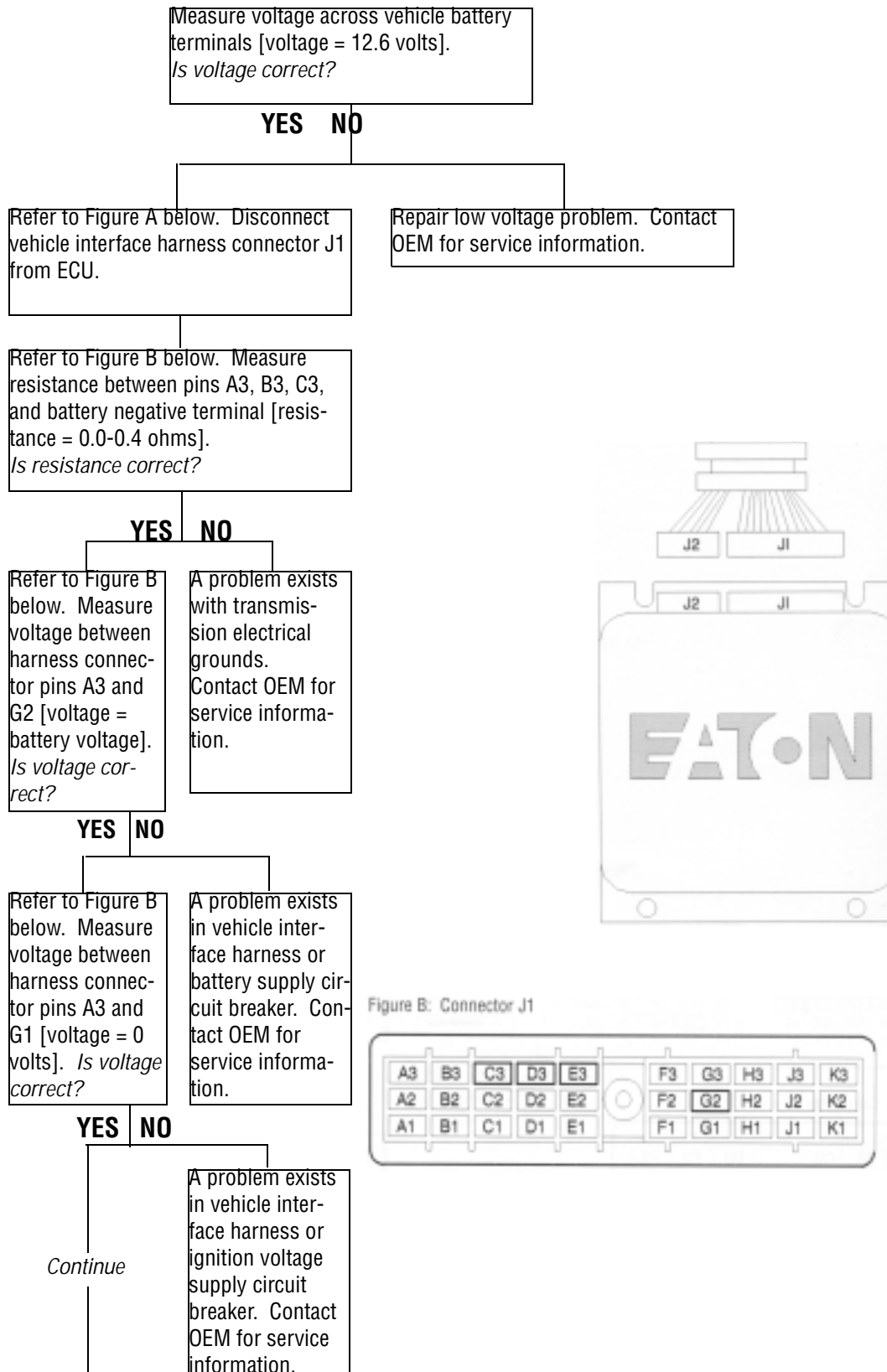
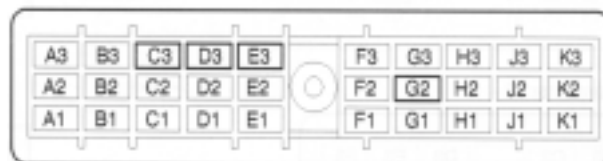


Figure B: Connector J1





# System

# Voltage

# Test

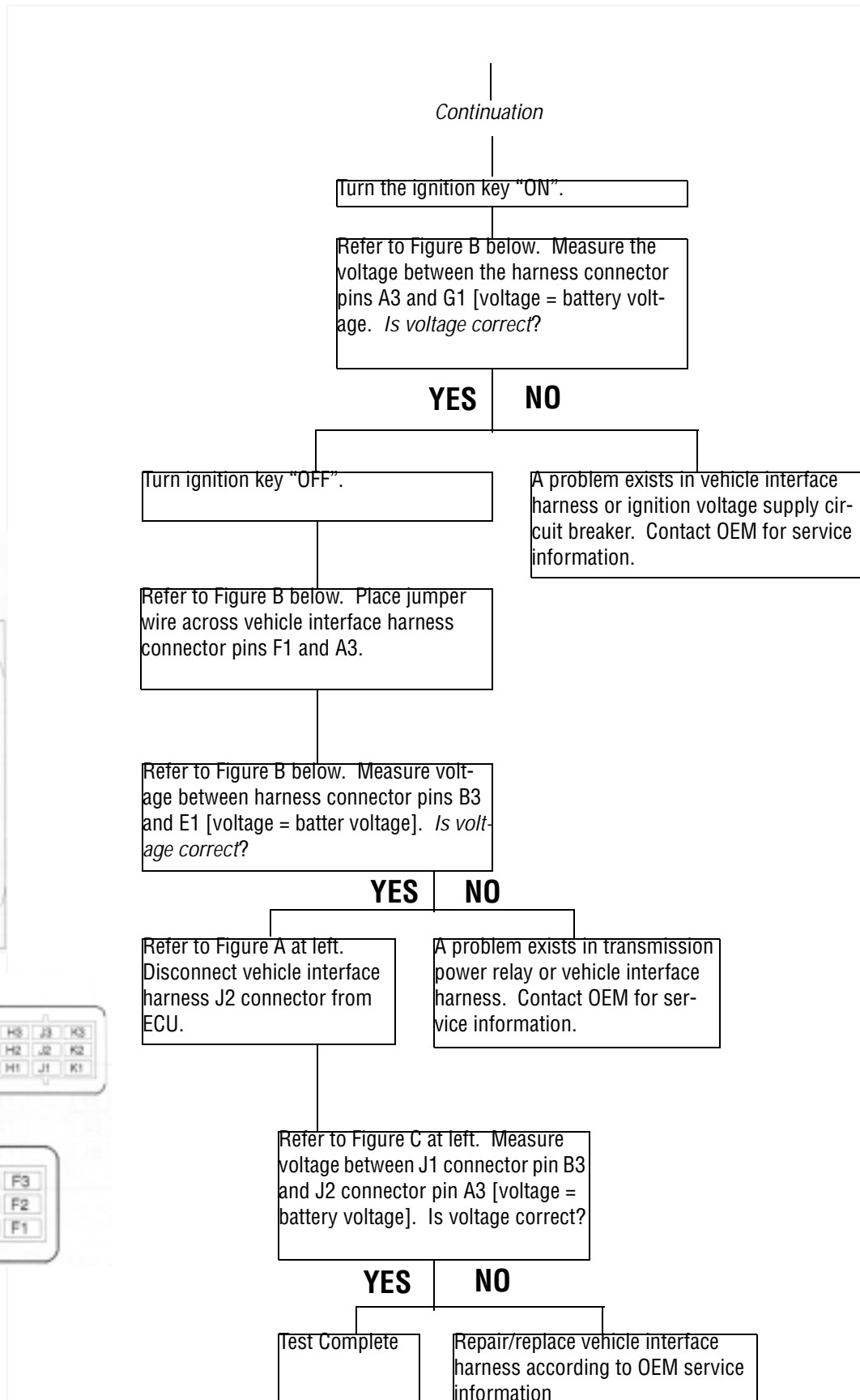
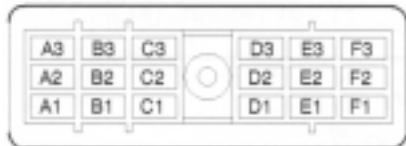
For all questions concerning inspection, removal, replacement, or adjustment procedures, refer to Eaton or OEM Service and Parts Literature.



Figure B: Connector J1

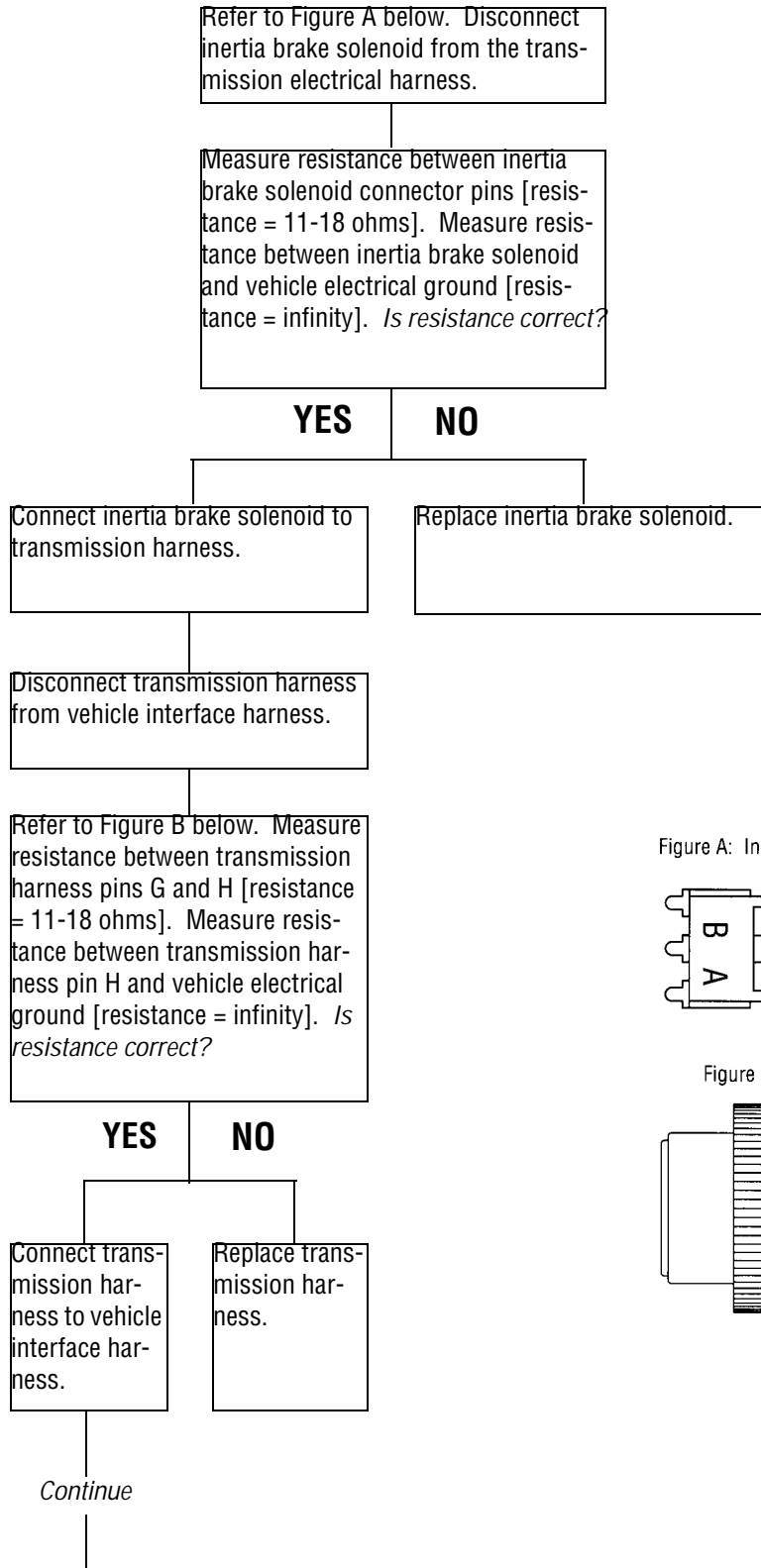


Figure C: Connector J2



**Before beginning test procedure:**

1. Set parking brakes.
2. Perform Transmission Electrical Test.
3. Turn ignition key "OFF".



For all questions concerning inspection, removal, replacement, or adjustment procedures, refer to Eaton or OEM Service and Parts Literature.

Figure A: Inertia Brake Solenoid Connector

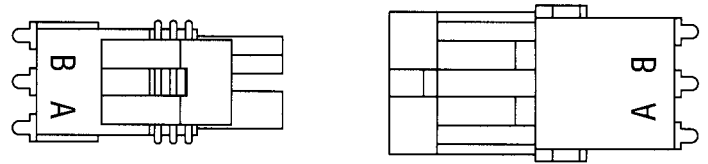
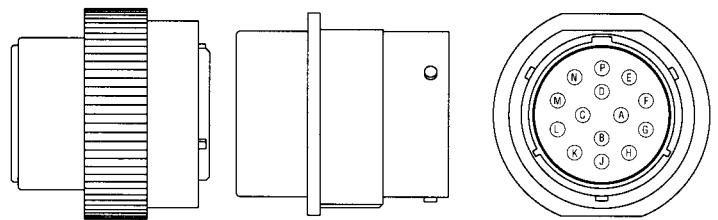


Figure B: Transmission Harness Connector



**Inertia  
Brake  
Solenoid  
Coil Test**

For all questions concerning inspection, removal, replacement, or adjustment procedures, refer to Eaton or OEM Service and Parts Literature.

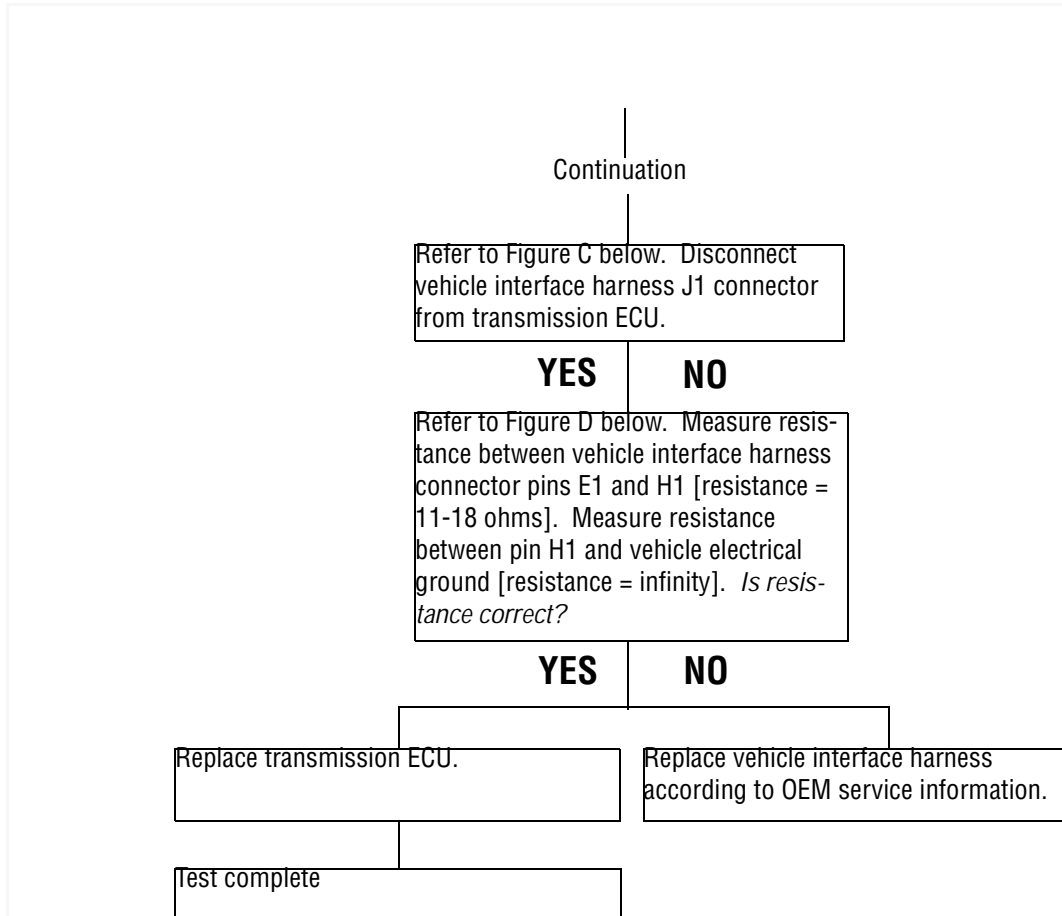


Figure C: Vehicle Interface Harness

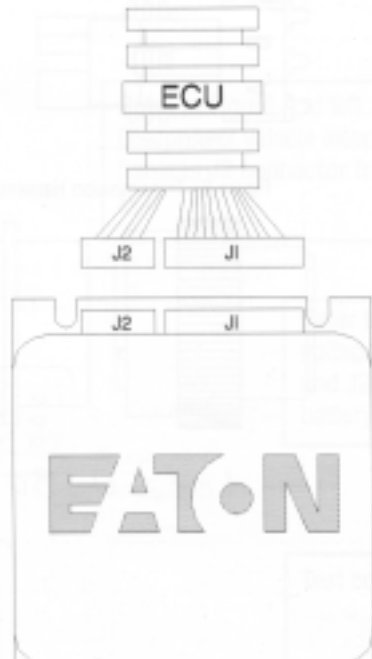
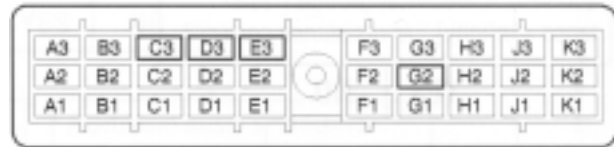


Figure D: Connector J1



**Before beginning test procedure:**

1. Set parking brakes.
2. Perform Transmission Electrical Test.
3. Turn ignition key "OFF".

For all questions concerning inspection, removal, replacement, or adjustment procedures, refer to Eaton or OEM Service and Parts Literature.

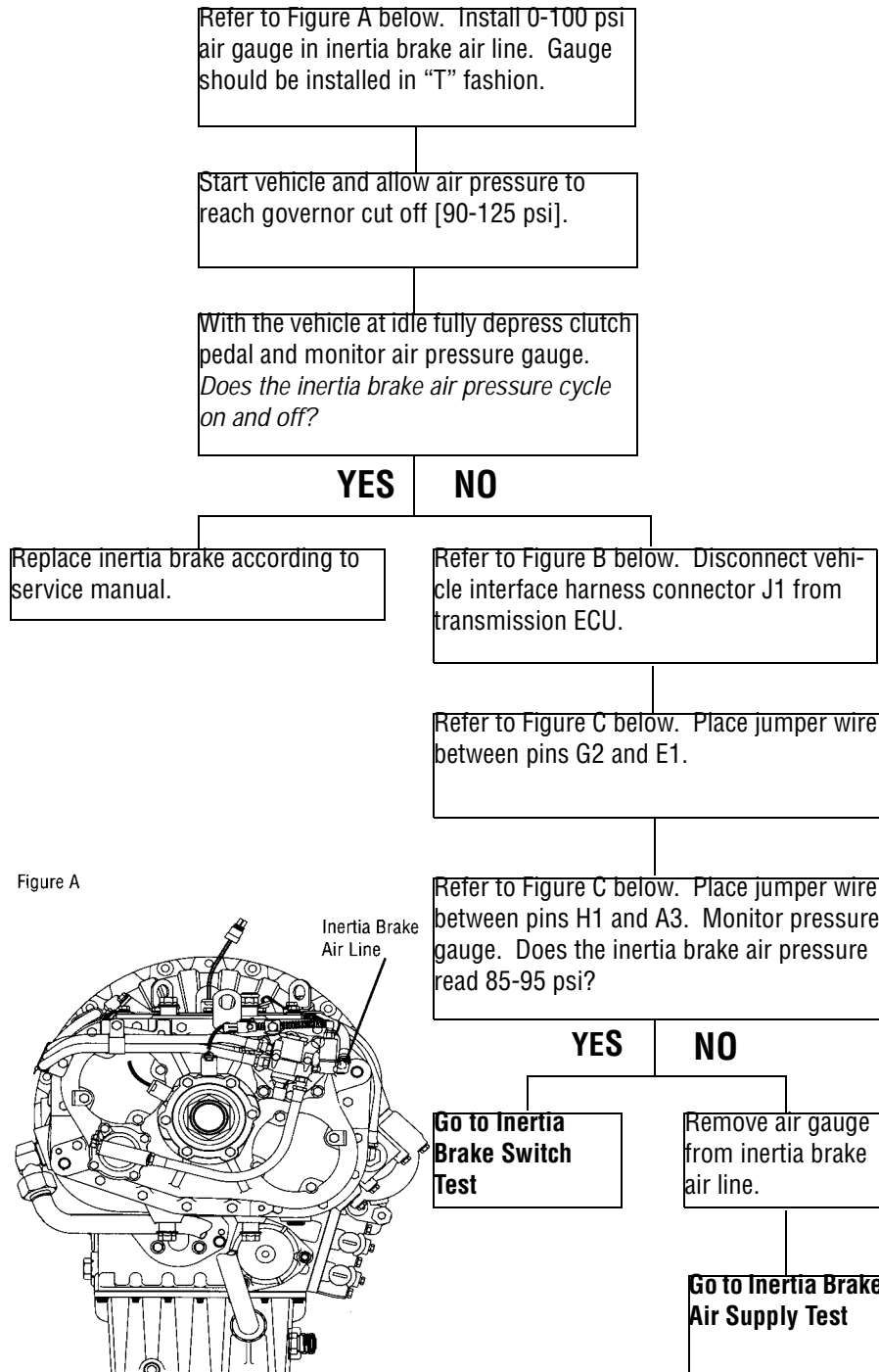


Figure A

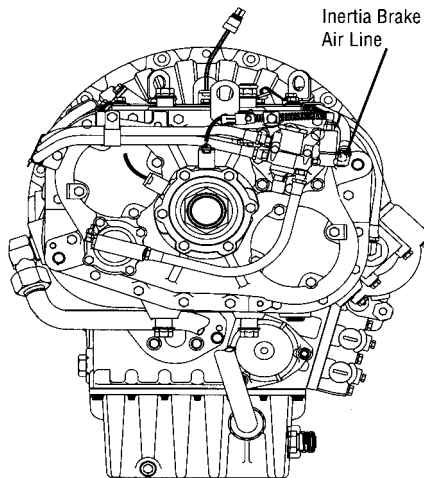


Figure B: Vehicle Interface Harness

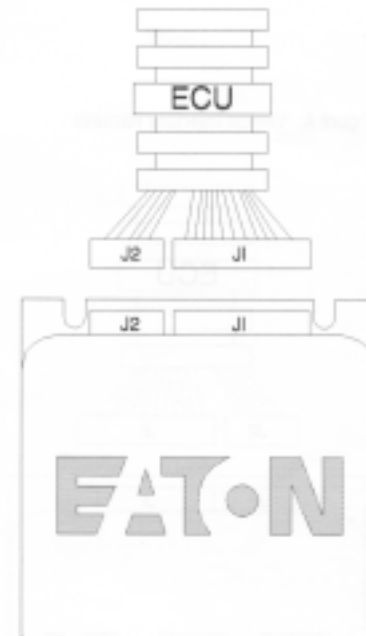
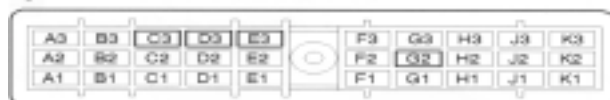


Figure C: Connector J1



# Inertia Brake Switch Test

For all questions concerning inspection, removal, replacement, or adjustment procedures, refer to Eaton or OEM Service and Parts Literature.

**Before beginning test procedure:**

1. Set parking brakes.
2. Perform Transmission Electrical Test.
3. Turn ignition key "OFF".

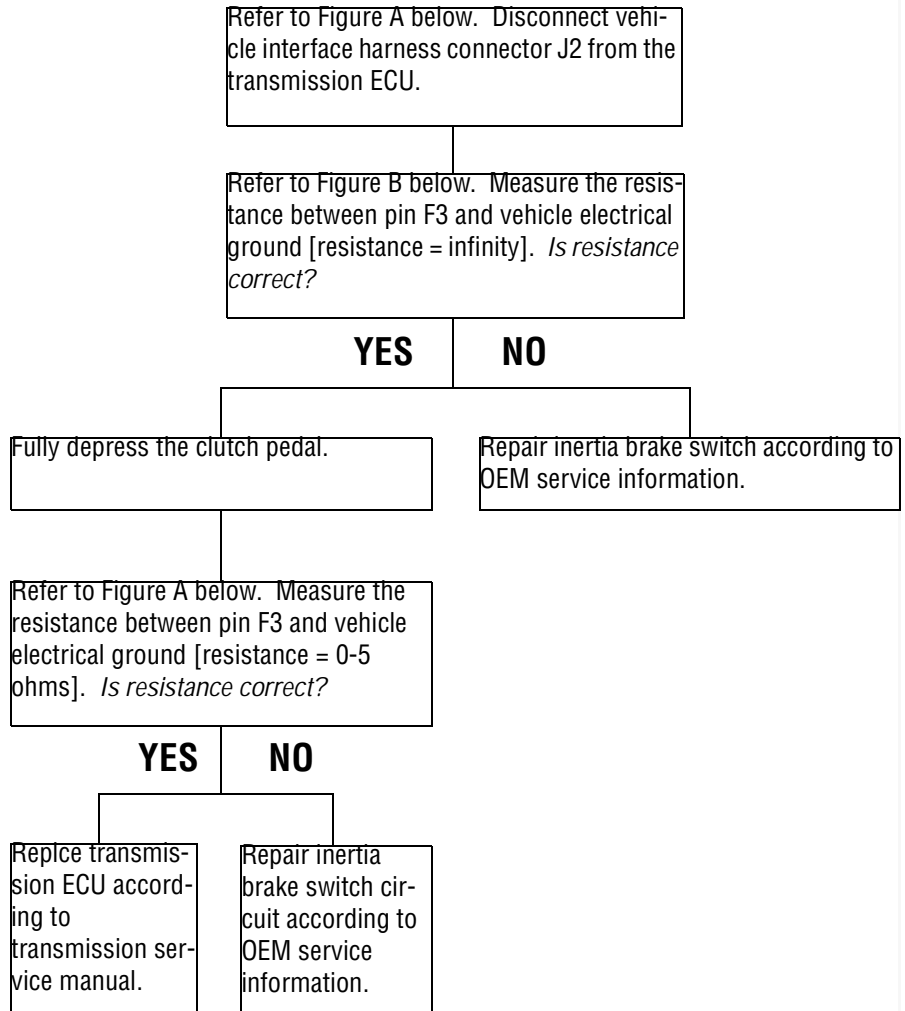


Figure A: Vehicle Interface Harness

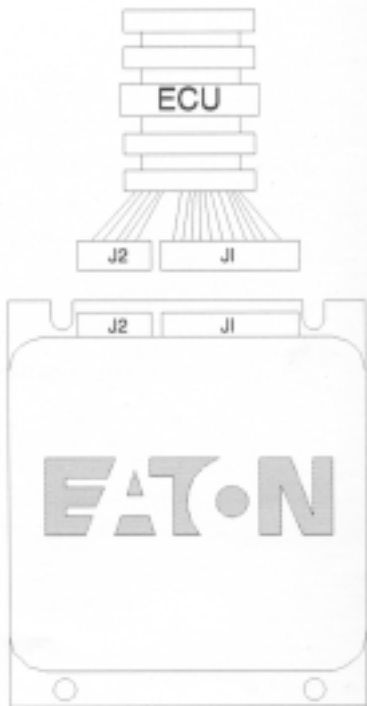
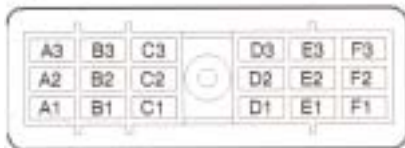


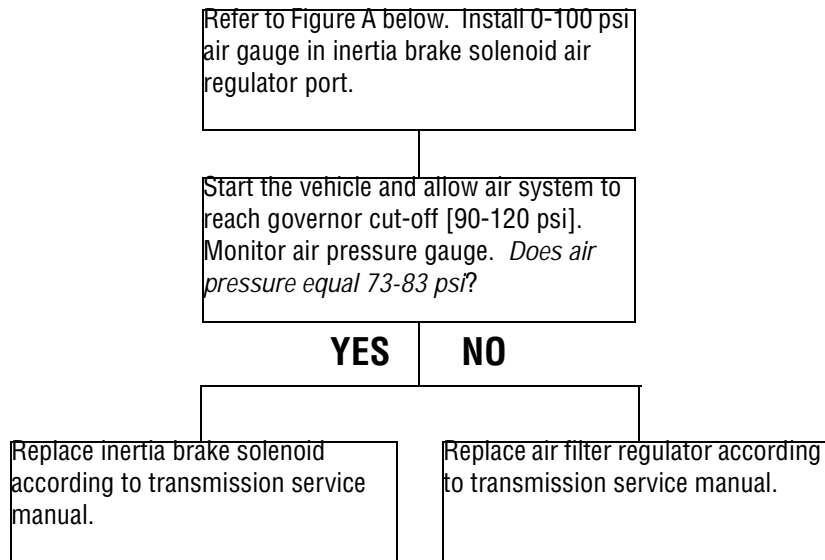
Figure B: Connector J2



# Inertia Brake Air Supply Test

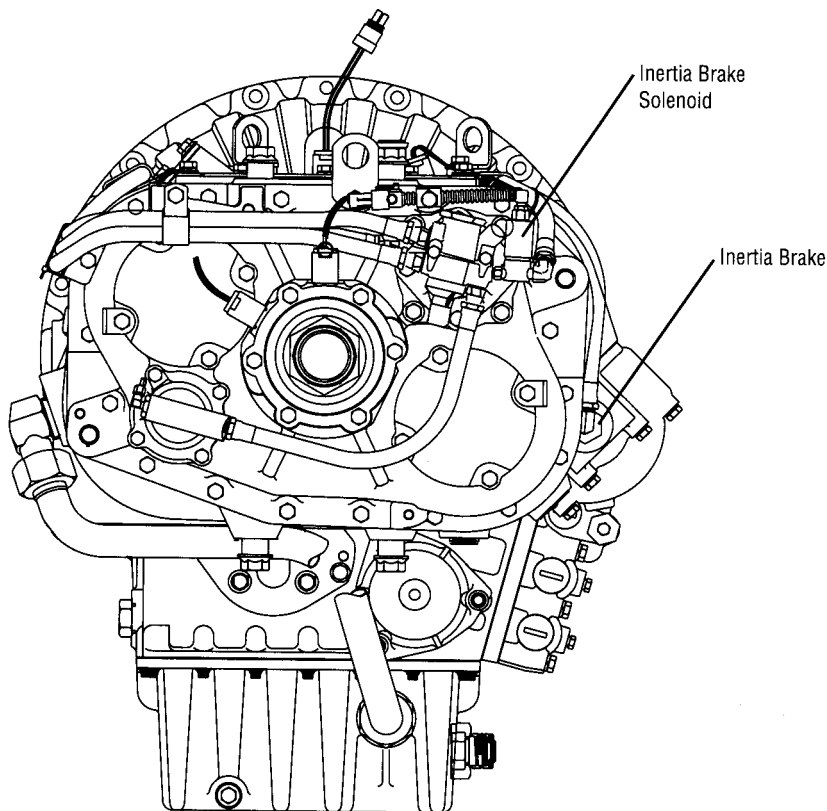
## Before beginning test procedure:

1. Set parking brakes.
2. Perform Transmission Electrical Test.
3. Turn ignition key "OFF".



For all questions concerning inspection, removal, replacement, or adjustment procedures, refer to Eaton or OEM Service and Parts Literature.

Figure A



# Transmission Converter Open Lamp Test

For all questions concerning inspection, removal, replacement, or adjustment procedures, refer to Eaton or OEM Service and Parts Literature.

### Before beginning test procedure:

1. Set parking brakes.
2. Perform Transmission Electrical Test.
3. Turn ignition key "OFF".

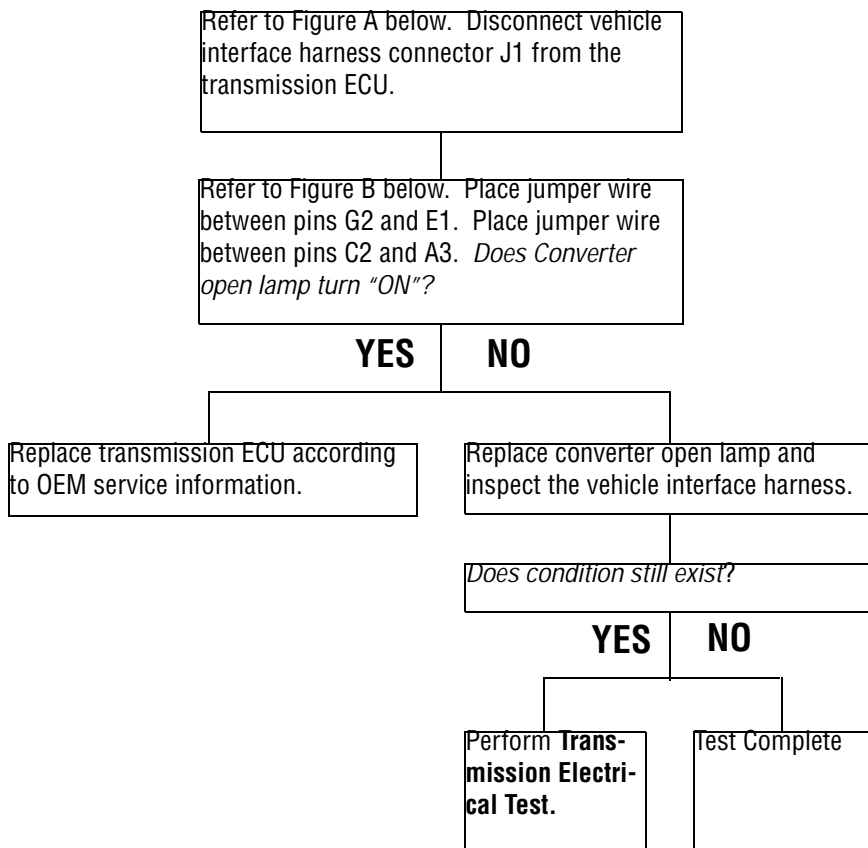


Figure A: Vehicle Interface Harness

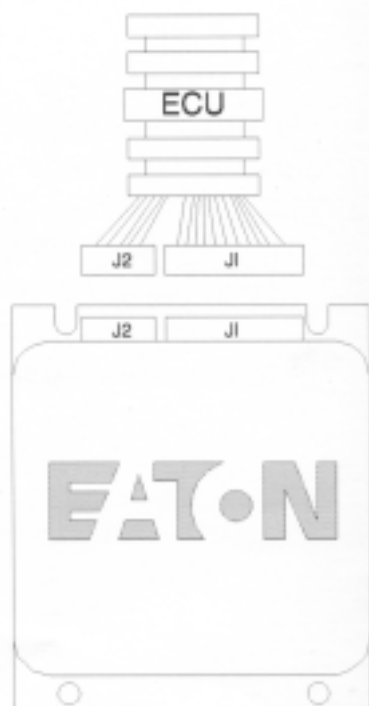
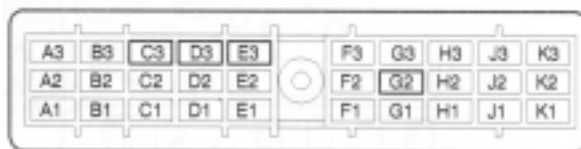


Figure B: Connector J1



**Before beginning test procedure:**

1. Set parking brakes.
2. Perform Transmission Electrical Test.
3. Turn ignition key "OFF".

# Engine Speed Sensor Test

For all questions concerning inspection, removal, replacement, or adjustment procedures, refer to Eaton or OEM Service and Parts Literature.

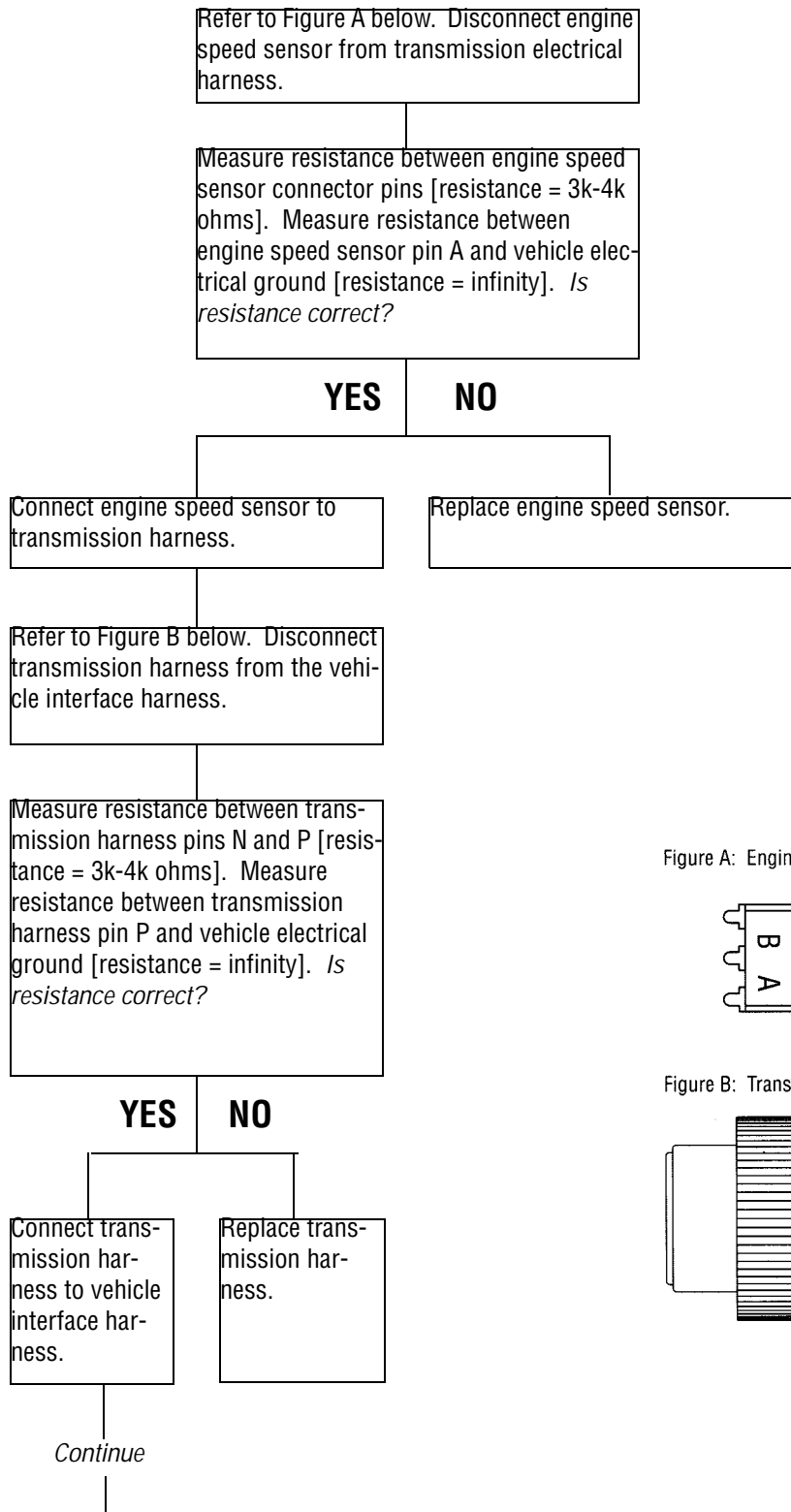


Figure A: Engine Speed Sensor Connector

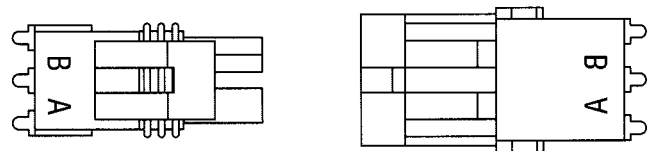
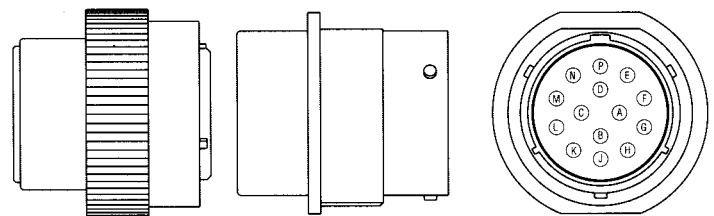


Figure B: Transmission Harness Connector





# Engine Speed Sensor Test

For all questions concerning inspection, removal, replacement, or adjustment procedures, refer to Eaton or OEM Service and Parts Literature.

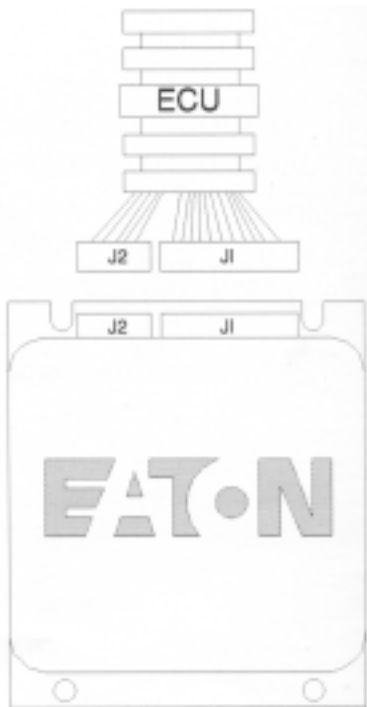
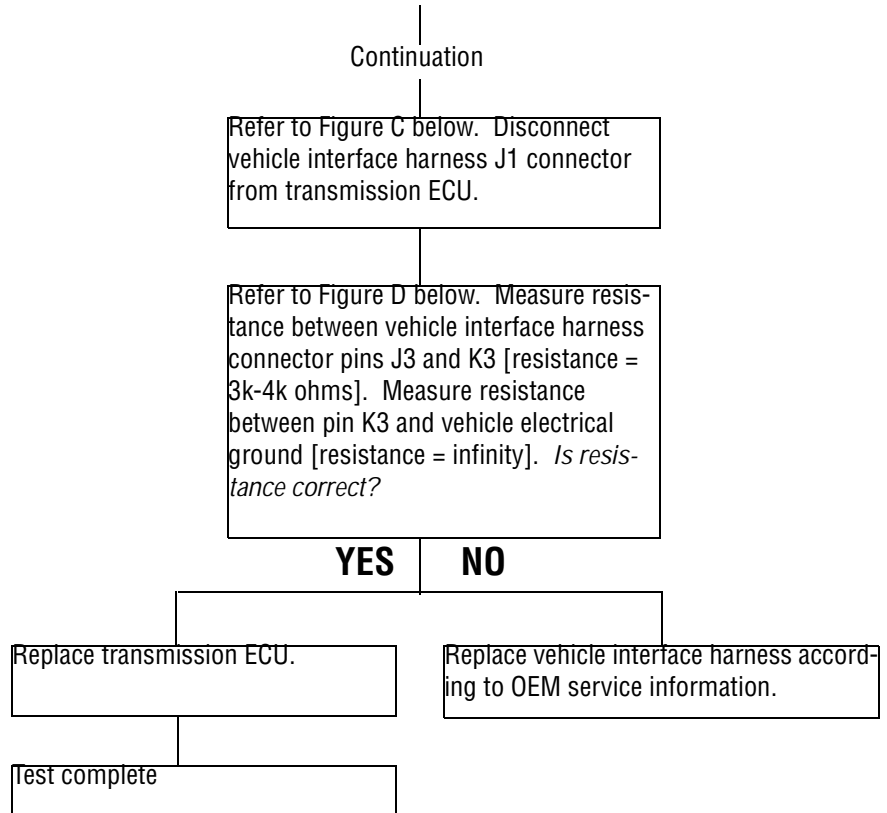
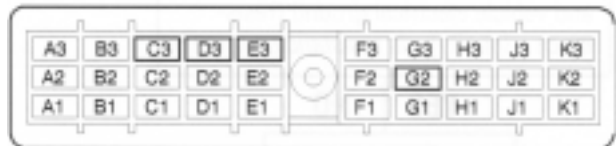


Figure D: Connector J1



**Before beginning test procedure:**

1. Set parking brakes.
2. Perform Transmission Electrical Test.
3. Turn ignition key "OFF".

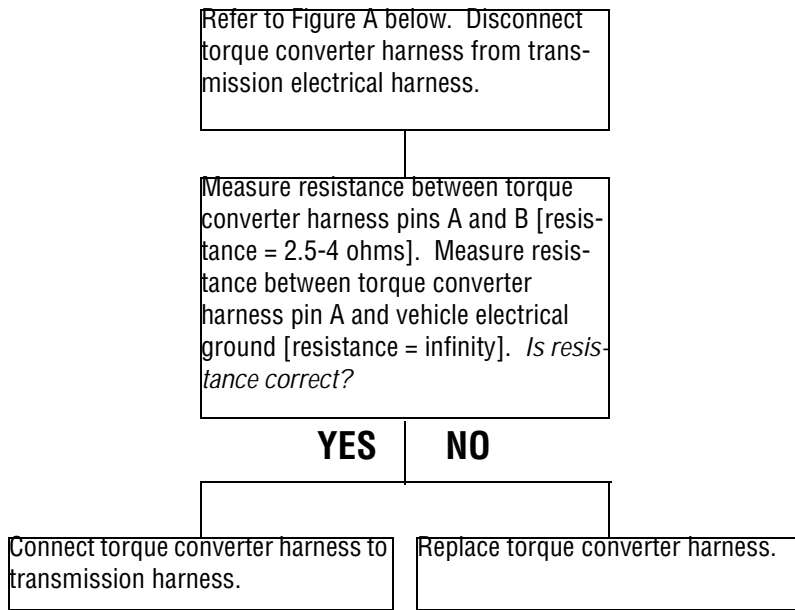


Figure A: Torque Converter Harness Connector

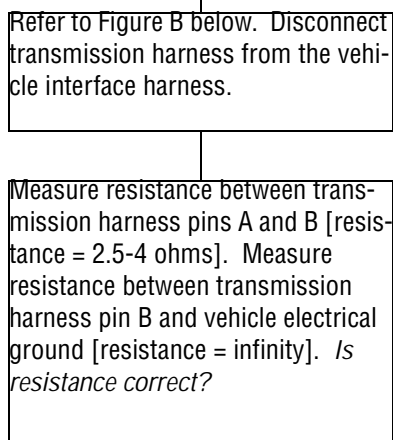
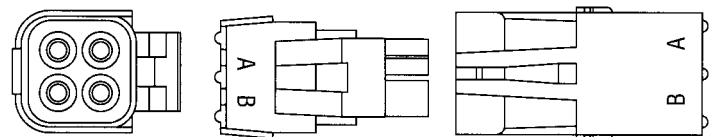
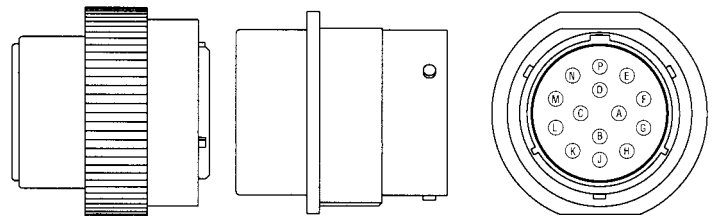


Figure B: Transmission Harness Connector



Continue

## Bypass/ Lockup Solenoid Coil Test

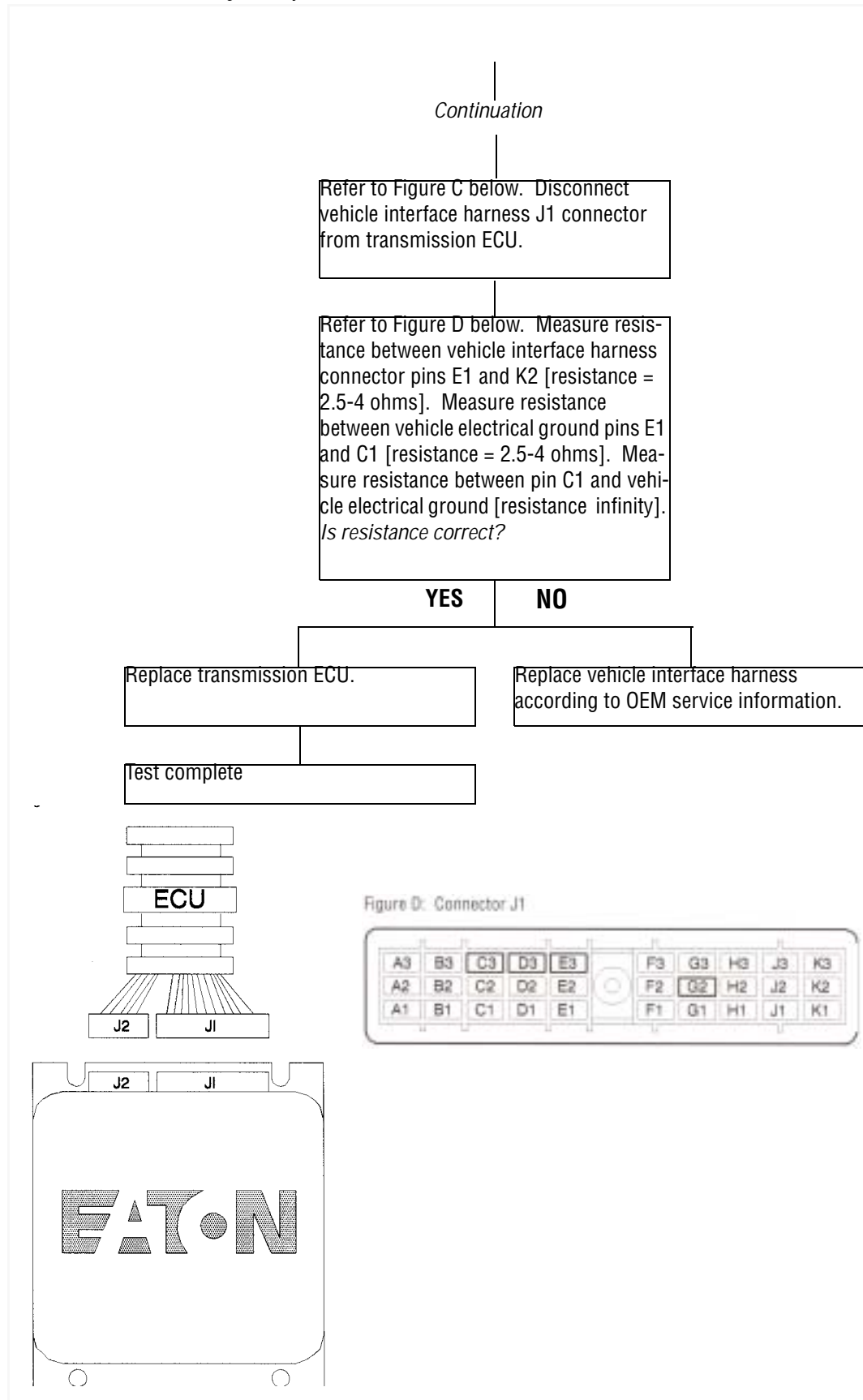
For all questions concerning inspection, removal, replacement, or adjustment procedures, refer to Eaton or OEM Service and Parts Literature.

# Bypass/ Lockup Solenoid Coil Test

For all questions concerning inspection, removal, replacement, or adjustment procedures, refer to Eaton or OEM Service and Parts Literature.

### Before beginning test procedure:

1. Set parking brakes.
2. Perform Transmission Electrical Test.
3. Turn ignition key "OFF".



**Before beginning test procedure:**

1. Set parking brakes.
2. Perform Transmission Electrical Test.
3. Turn ignition key "OFF".

# Interrupt Clutch Solenoid Coil Test

For all questions concerning inspection, removal, replacement, or adjustment procedures, refer to Eaton or OEM Service and Parts Literature.

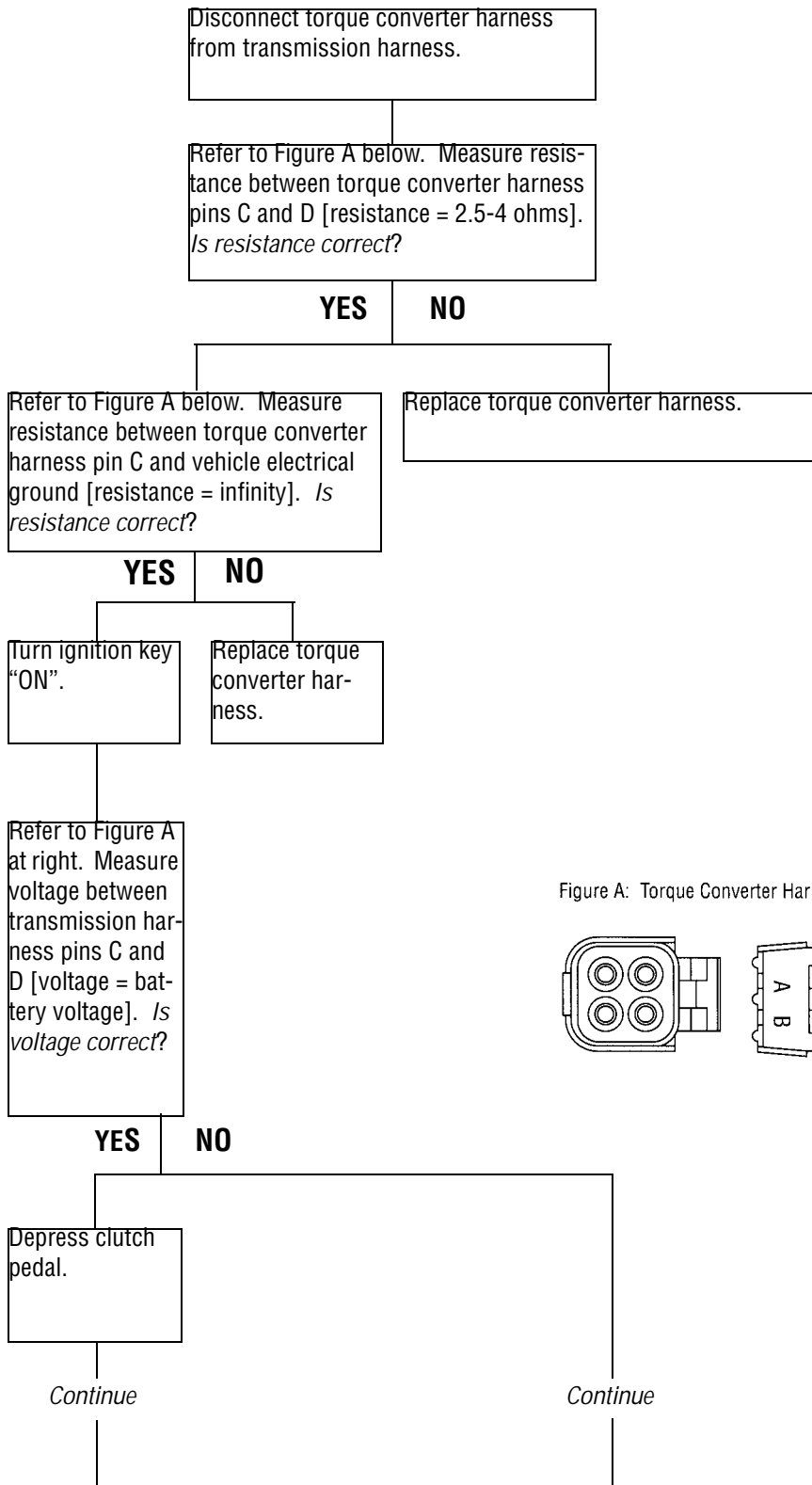
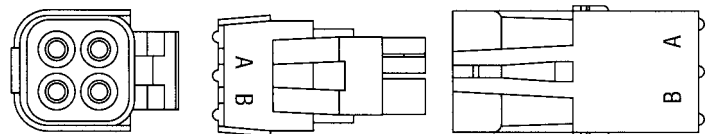


Figure A: Torque Converter Harness Connector



# Interrupt Clutch Solenoid Coil Test

For all questions concerning inspection, removal, replacement, or adjustment procedures, refer to Eaton or OEM Service and Parts Literature.

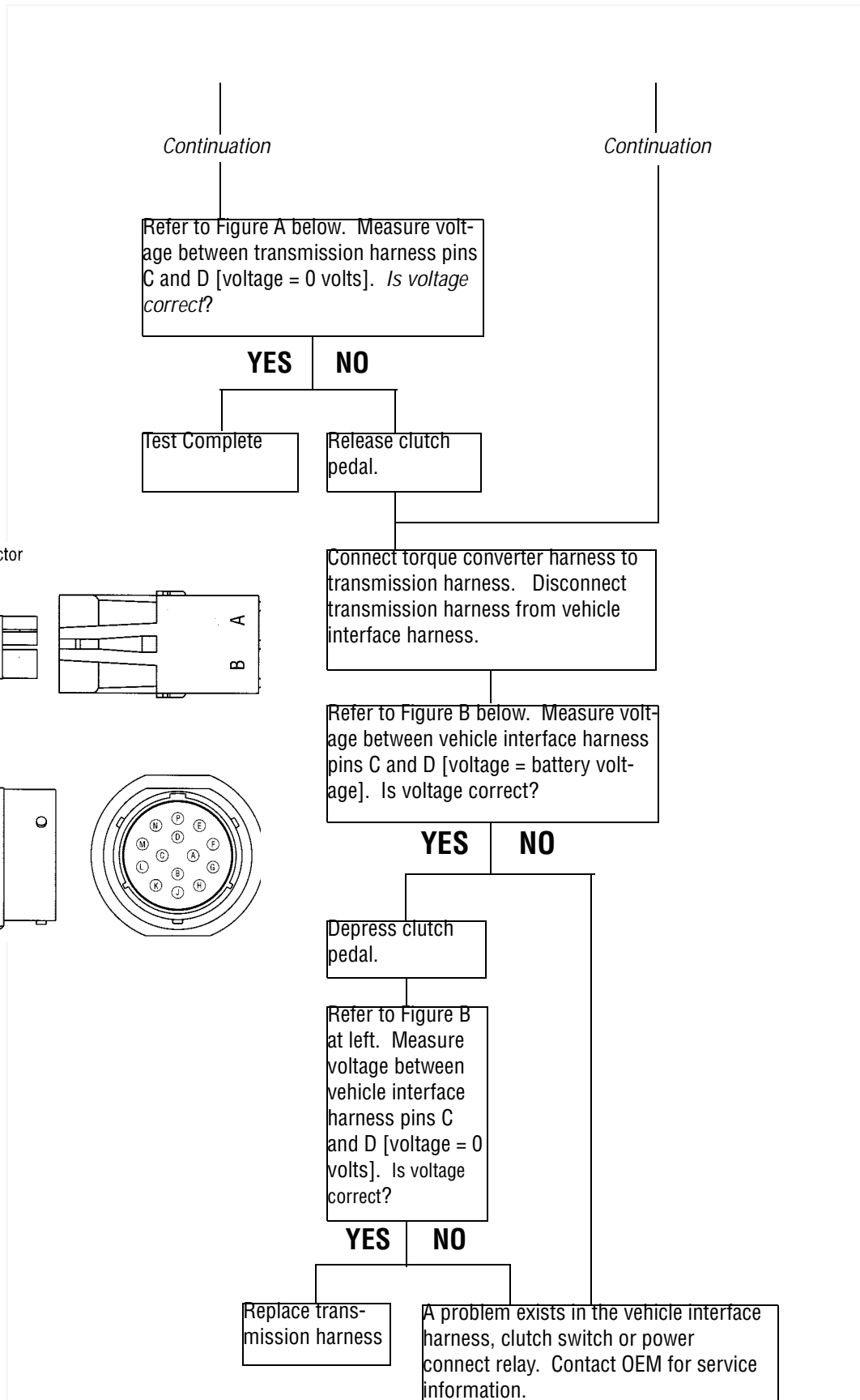


Figure A: Torque Converter Harness Connector

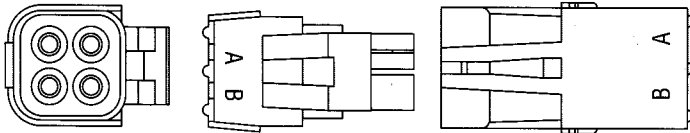
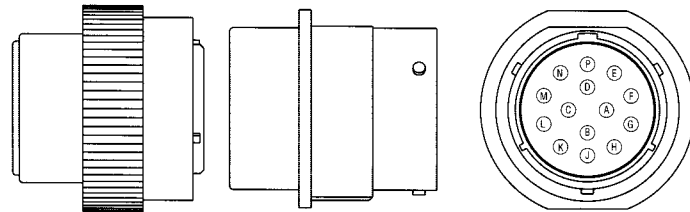


Figure B: Transmission Harness Connector



**Before beginning test procedure:**

1. Set parking brakes.
2. Perform Transmission Electrical Test.
3. Turn ignition key "OFF".

For all questions concerning inspection, removal, replacement, or adjustment procedures, refer to Eaton or OEM Service and Parts Literature.

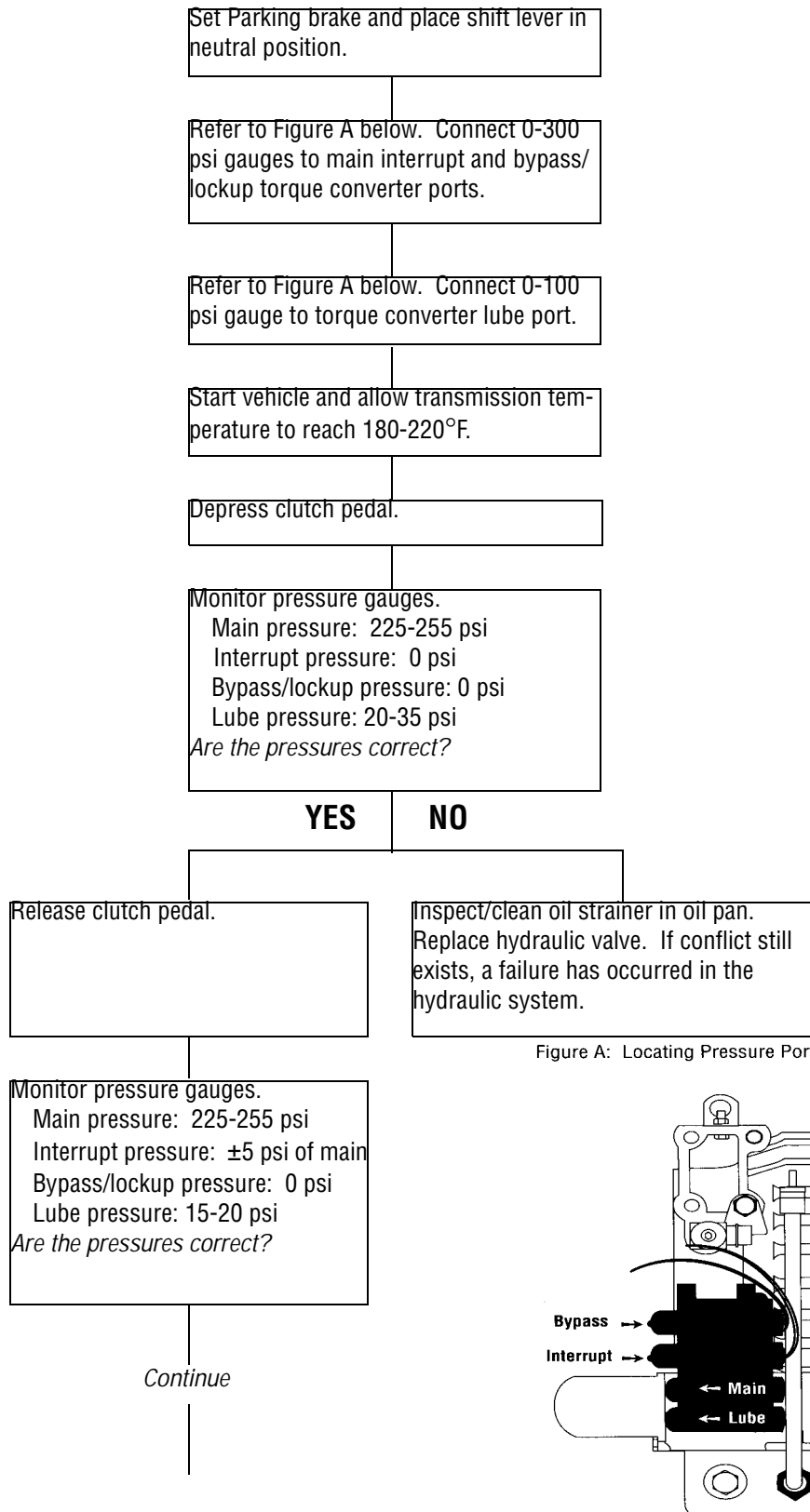
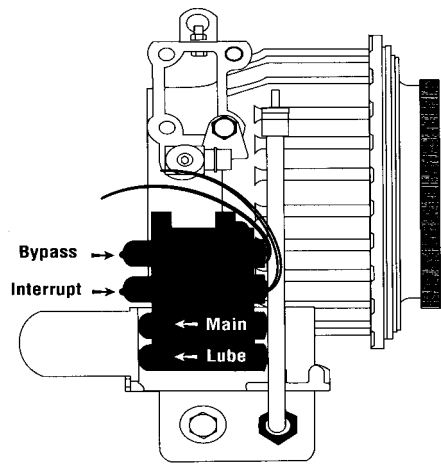
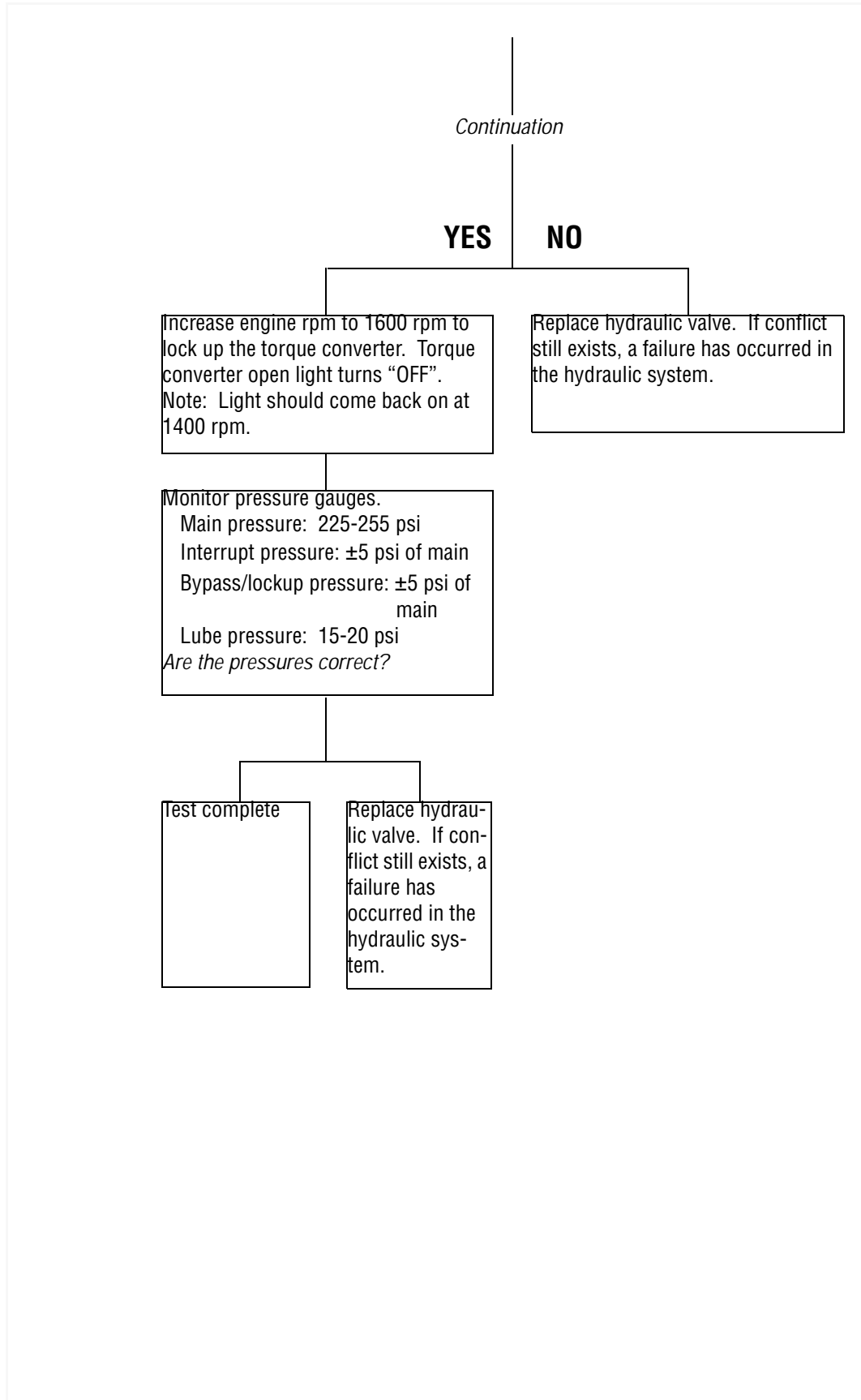


Figure A: Locating Pressure Ports



# Hydraulic System Test

For all questions concerning inspection, removal, replacement, or adjustment procedures, refer to Eaton or OEM Service and Parts Literature.



# Input Shaft Speed Sensor Test

**Before beginning test procedure:**

1. Set parking brakes.
2. Perform Transmission Electrical Test.
3. Turn ignition key "OFF".

For all questions concerning inspection, removal, replacement, or adjustment procedures, refer to Eaton or OEM Service and Parts Literature.

Refer to Figure A below. Disconnect input shaft speed sensor from the transmission electrical harness.

Measure resistance between input shaft speed sensor connector pins [resistance = 3k-4k ohms]. Measure resistance between input shaft speed sensor pin A and vehicle electrical ground [resistance = infinity].  
*Is resistance correct?*

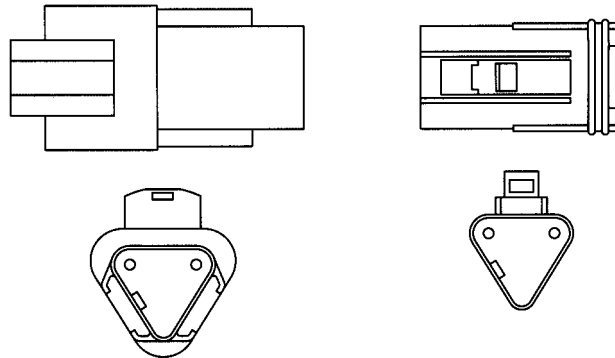
**YES NO**

Connect input shaft speed sensor to transmission harness.

Replace the input shaft speed sensor.

Refer to Figure B below. Disconnect transmission harness from vehicle interface harness.

Figure A: Speed Sensor Connector



Measure resistance between transmission harness pins J and K [resistance = 3k-4k ohms]. Measure resistance between transmission harness pin K and vehicle electrical ground [resistance = infinity].  
*Is resistance correct?*

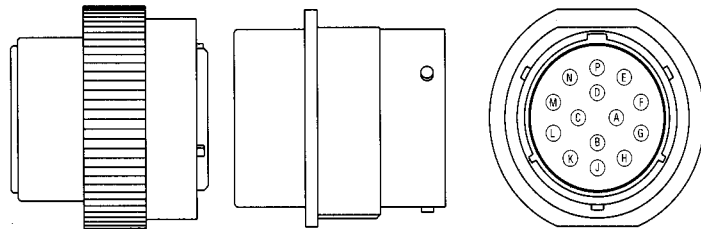
**YES NO**

Connect transmission harness to transmission electrical harness.

Replace the transmission harness.

Continue

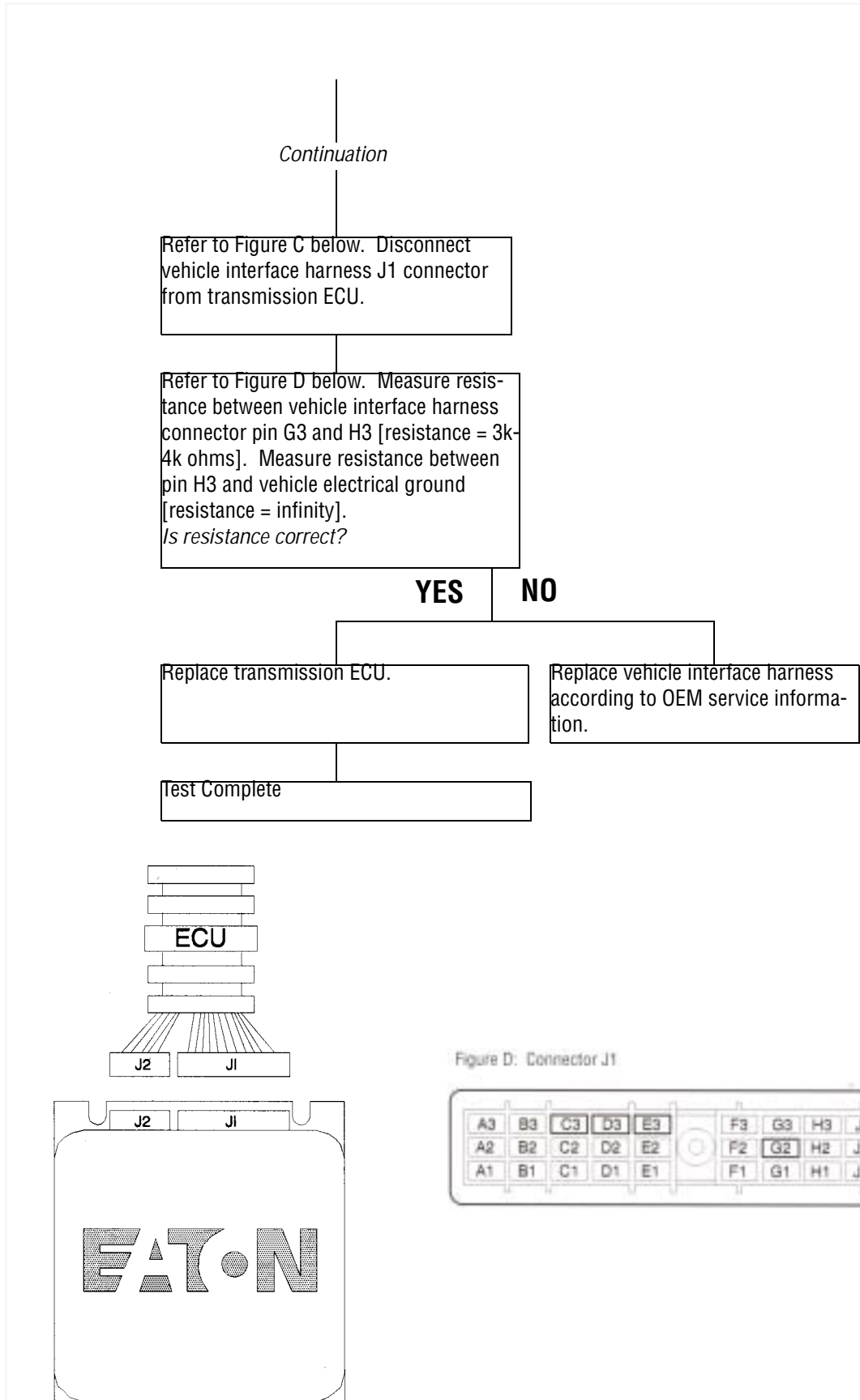
Figure B: Transmission Harness Connector





**Input  
Shaft  
Sensor  
Test**

For all questions concerning inspection, removal, replacement, or adjustment procedures, refer to Eaton or OEM Service and Parts Literature.



**Before beginning test procedure:**

1. Set parking brakes.
2. Perform Transmission Electrical Test.
3. Turn ignition key "OFF".

# Output Shaft Speed Sensor Test

For all questions concerning inspection, removal, replacement, or adjustment procedures, refer to Eaton or OEM Service and Parts Literature.

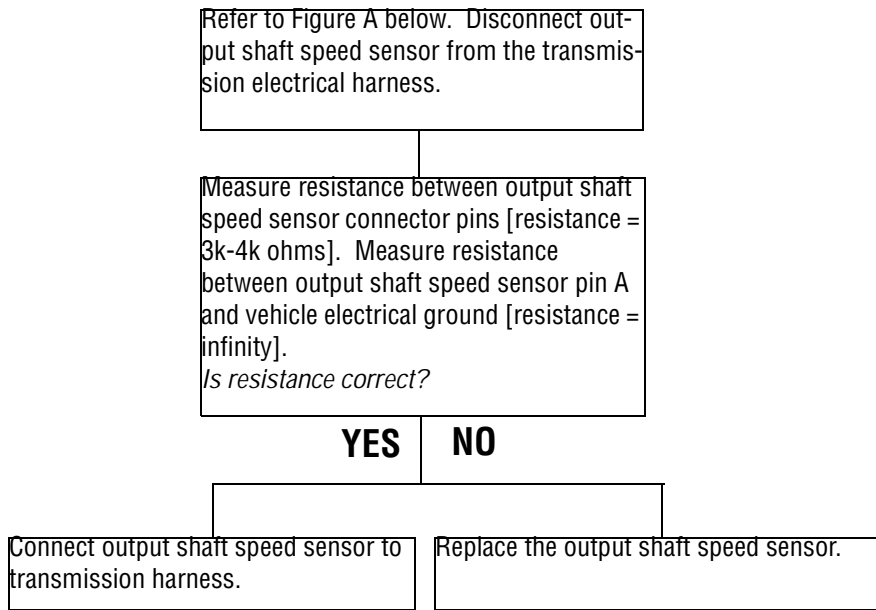


Figure A: Speed Sensor Connector

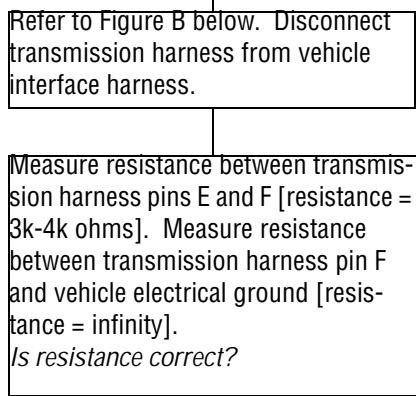
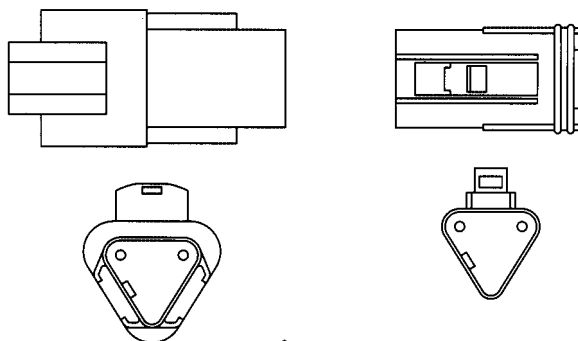
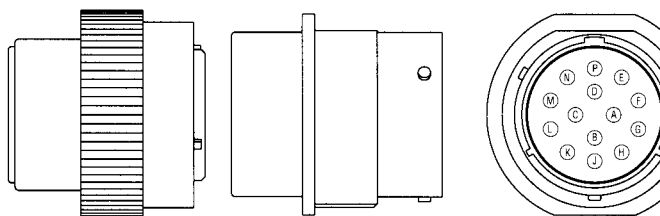


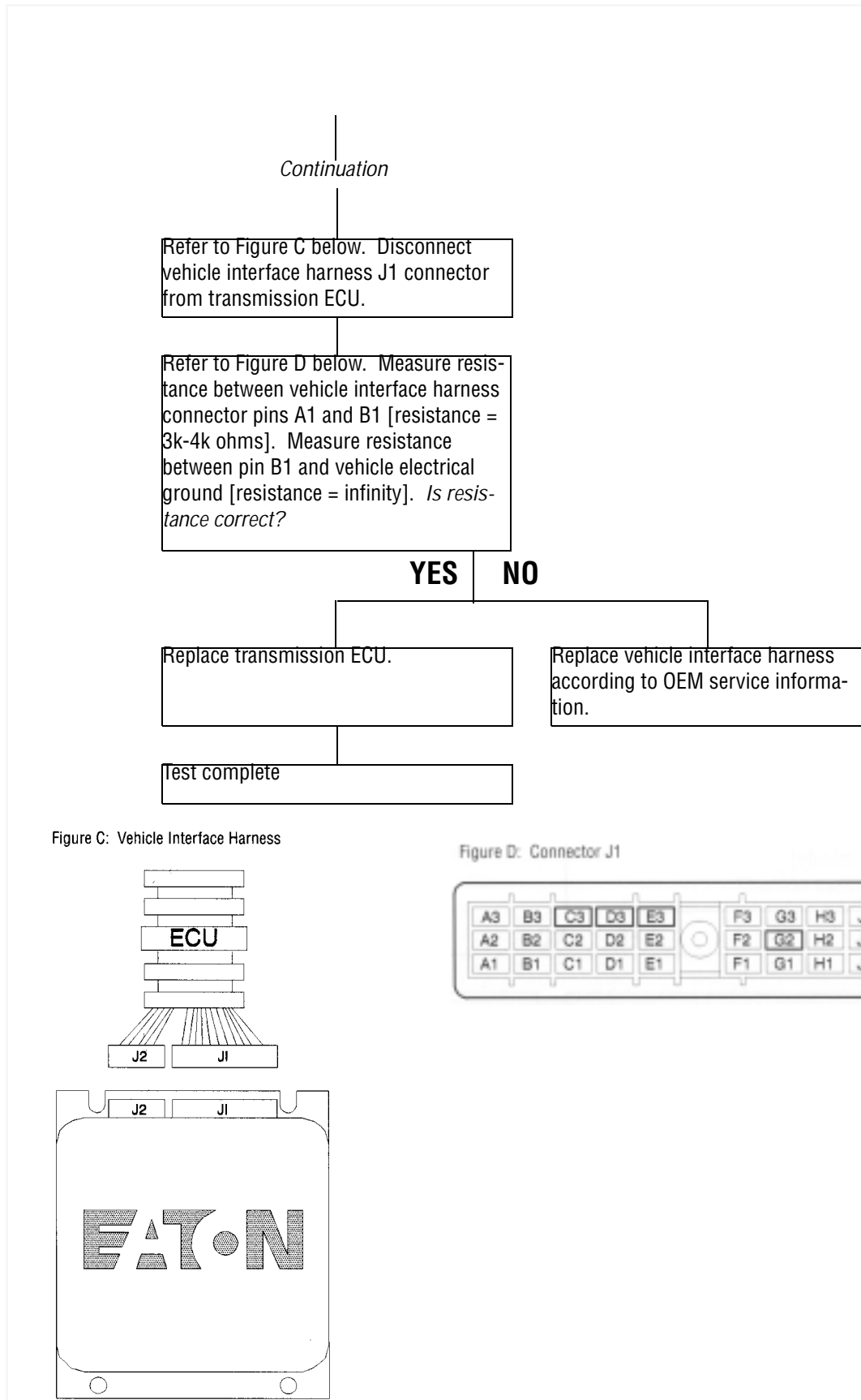
Figure B: Transmission Harness Connector



Continue

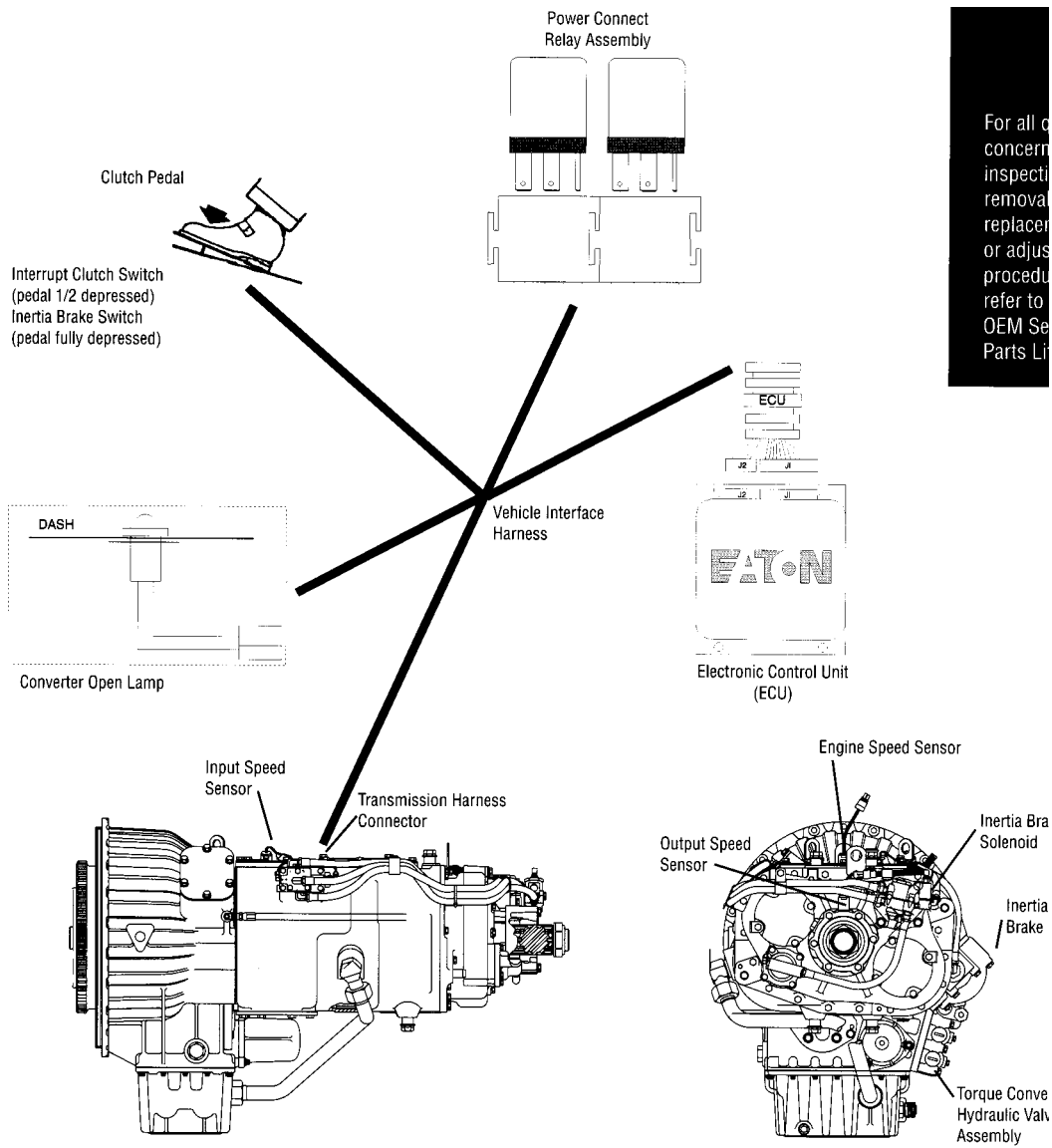
# Output Shaft Sensor Test

For all questions concerning inspection, removal, replacement, or adjustment procedures, refer to Eaton or OEM Service and Parts Literature.



System Overview

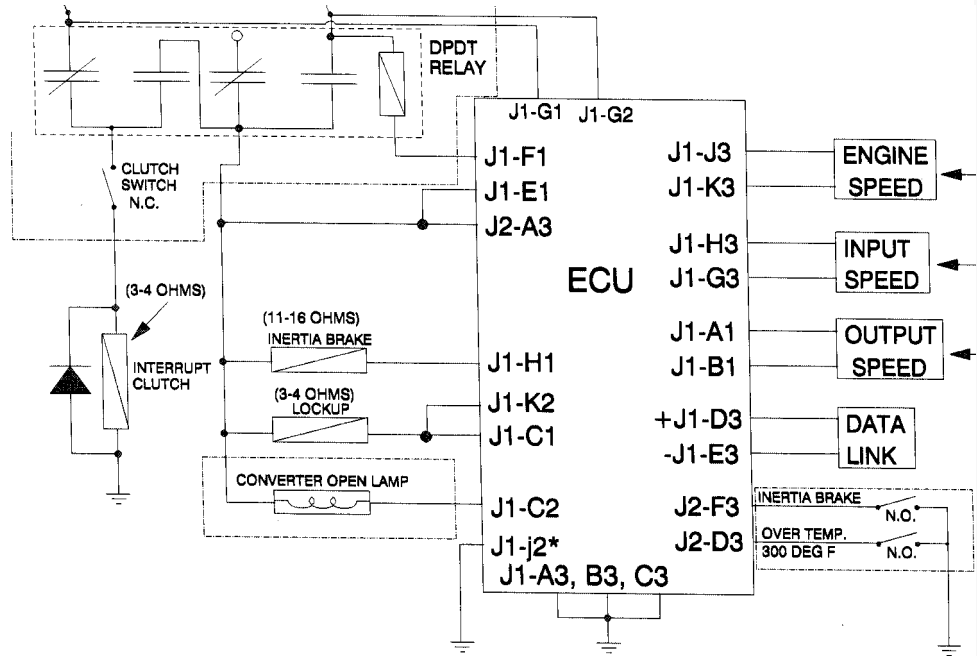
For all questions concerning inspection, removal, replacement, or adjustment procedures, refer to Eaton or OEM Service and Parts Literature.



# Appendix I

For all questions concerning inspection, removal, replacement, or adjustment procedures, refer to Eaton or OEM Service and Parts Literature.

## Electrical Schematic



\*Ground pin J2 only for 11118. Leave open for a 9118.

**Everything in dashed boxes supplied by OEM.**



Copyright Eaton Corporation, 2012. Eaton hereby grant their customers, vendors, or distributors permission to freely copy, reproduce and/or distribute this document in printed format. It may be copied only in its entirety without any changes or modifications. THIS INFORMATION IS NOT INTENDED FOR SALE OR RESALE, AND THIS NOTICE MUST REMAIN ON ALL COPIES.

**Note:** Features and specifications listed in this document are subject to change without notice and represent the maximum capabilities of the software and products with all options installed. Although every attempt has been made to ensure the accuracy of information contained within, Eaton makes no representation about the completeness, correctness or accuracy and assumes no responsibility for any errors or omissions. Features and functionality may vary depending on selected options.

**For spec'ing or service assistance, call 1-800-826-HELP (4357) or visit [www.eaton.com/roadranger](http://www.eaton.com/roadranger). In Mexico, call 001-800-826-4357.**

Roadranger: Eaton and trusted partners providing the best products and services in the industry, ensuring more time on the road.

**Eaton Corporation**

Vehicle Group  
P.O. Box 4013  
Kalamazoo, MI 49003 USA  
800-826-HELP (4357)  
[www.eaton.com/roadranger](http://www.eaton.com/roadranger)

Printed in USA

For parts or service call us  
Pro Gear & Transmission, Inc.



**1 (877) 776-4600**

**(407) 872-1901**

**parts@eprogear.com**

**906 W. Gore St.**

**Orlando, FL 32805**

